

# Dryer

## User Manual

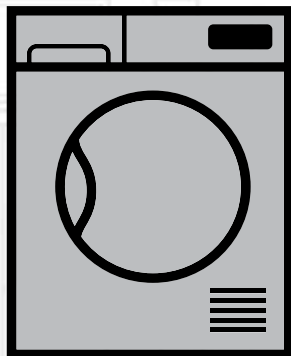

DTGC7000 W

DTGC7000 S

DTGC7000 B

EN

2960311511\_EN/210717.1605

CE

**beko**

# Please read this user manual first!

Dear Customer,







Thank you for preferring a Beko product. We hope that your product which has been manufactured with high quality and technology will give you the best results. We advise you to read through this manual and the other accompanying documentation carefully before using your product and keep it for future reference. If you transfer the product to someone else, give its manual as well. Pay attention to all details and warnings specified in the user manual and follow the instructions given therein.

Use this user manual for the model indicated on the cover page.



## Explanation of symbols

Throughout this user manual the following symbols are used:

	Important information or useful hints about usage.
	Warning for hazardous situations with regard to life and property.
	Warning against electric shock.
	Warning against hot surfaces.
	Warning against fire hazard.
	Warning against scalding hazard.
	Packaging materials of the product are manufactured from recyclable materials in accordance with our National Environment Regulations.

Do not dispose of the packaging wastes with the domestic waste or other wastes, discard them to the dedicated collection points designated by the local authorities.



This product was manufactured using the latest technology in environmentally friendly conditions.

---

# TABLE OF CONTENTS

---

## **1 Important safety and environmental instructions**

---

1.1 General safety .....	4
1.1.1 Electrical safety .....	5
1.1.2 Product safety .....	6
1.2 Mounting over a washing machine .....	8
1.3 Intended use .....	9
1.4 Child safety .....	9
1.5 Compliance with the WEEE regulation and disposing of the waste product .....	10
1.6 Compliance with RoHS Directive:.....	10
1.7 Package information .....	10
1.8 Technical specifications .....	11

## **2 Your Dryer** **12**

---

2.1 Overview .....	12
2.2 Package Contents .....	12

## **3 Installation** **13**

---

3.1 Appropriate installation location .....	13
3.2 Removing the transportation safety assembly .....	13
3.3 Connecting to the drain .....	13
3.4 Adjusting the feet .....	14
3.5 Transportation of the dryer .....	14
3.6 Changing the illumination lamp .....	14

## **4 Preparation** **15**

---

4.1 Laundry suitable for drying in the dryer	15
4.2 Laundry not suitable for drying in the dryer .....	15
4.3 Preparing laundry for drying .....	15
4.4 Things to be done for energy saving ..	15
4.5 Correct load capacity .....	15

## **5 Operating the product** **17**

---

5.1 Control Panel .....	17
5.2 Symbols .....	17
5.3 Preparation of drying machine .....	17
5.4 Program selection and consumption tablee .....	18
5.5 Auxiliary functions .....	19
5.6 Warning indicators .....	20
5.7 Starting the program .....	20
5.8 Child Lock .....	20

5.9 Changing the program after it is started .....	21
5.10 Cancelling the program .....	21
5.11 End of program .....	21

## **6 Maintenance and cleaning** **22**

---

6.1 Lint Filter / Loading Door Inner Surface	22
6.2 Cleaning the sensors .....	23
6.3 Draining the water tank .....	23
6.4 For the condenser; .....	24

## **7 Troubleshooting** **25**

---

## **8 Service** **27**

---

8.1 Republic of Ireland .....	27
8.2 Service once the manufacturers guarantee has expired .....	27
8.3 UK Mainland & Northern Ireland .....	27

## **9 Electrical Connection** **28**

---

9.1 Attention! .....	28
9.2 Electrical requirements .....	28
9.3 Fitting a different plug .....	28
9.4 Washer/dryer combination .....	28

# 1 Important instructions for safety and environment

This section contains safety instructions that will help protect from risk of personal injury or property damage. Failure to follow these instructions shall void any warranty.

## 1.1 General safety

- The dryer can be used by children at and above 8 years old and by persons whose physical, sensory or mental capabilities were not fully developed or who lack experience and knowledge provided that they are supervised or trained on the safe usage of the product and the risks it brings out. Children should not play with the product. Cleaning and maintenance works should not be performed by children unless they are supervised by someone.
- Children of less than 3 years should be kept away unless continuously supervised.
- Adjustable feet should not be removed. The gap between the dryer and the floor should not be reduced with materials such as carpet, wood and tape. This will cause problems with the dryer.
- Always have the installation and repairing procedures carried out by the **Authorized Service**. Manufacturer shall not be held liable for damages that may arise from procedures carried out by unauthorized persons.
- Never wash the dryer by spraying or pouring water onto it! There is the risk of electric shock!

For the products with a steam function:

- Use only distilled water or water condensed in the water tank of the machine in steam programs. Do not use mains water or additives. When using condensed water in the water tank, it should be filtered and cleared of fibres.
- Do not open the door when steam programs are running. Hot water may be expelled.

# Important instructions for safety and environment

- Before putting laundry in a steam program, stains on it should be removed.
- You may only put laundry that is not dirty or stained but permeated with unpleasant odour in steam (odour removal) program.
- Do not use any dry cleaning sets or additional materials in a steam program or in any program.

## 1.1.1 Electrical safety



Electrical safety instructions should be followed while electrical connection is made during the installation.



The appliance must not be supplied through an external switching device, such as a timer, or connected to a circuit that is regularly switched on and off by utility.

- Connect the dryer to a grounded outlet protected by a fuse at the value specified on the type label. Have the grounding installation performed by a qualified electrician. Our company shall not be liable for any damages that will arise when the dryer is used without grounding in accordance with the local regulations.
- The voltage and allowed fuse protection is stated on the type label plate.
- The voltage specified on the type label must be equal to your mains voltage.
- Unplug the dryer when it is not in use.
- Unplug the dryer from the mains during installation, maintenance, cleaning and repair works.
- Do not touch the plug with wet hands! Never unplug by pulling on the cable, always pull out by grabbing the plug.
- Do not use extension cords, multi-plugs or adaptors to connect the dryer to power supply in order to decrease the risk of fire and electric shock.

# Important instructions for safety and environment

- Power cable plug must be easily accessible after installation.



Damaged mains cable should be changed notifying the Authorized Service.



If the dryer is faulty, it must not be operated unless it is repaired by an authorized service agent! There is the risk of electric shock!

## 1.1.2 Product safety



Superheating of the clothes inside of the dryer can occur if you cancel the programme or in the event of a power failure whilst the dryer is running, this concentration of heat can cause self-combustion and fire so always activate the ventilation programme to cool down or quickly remove all laundry from the dryer in order to hang them up and dissipate the heat.



### **Points to be taken into consideration for fire hazard:**

Below specified laundry or items must not be dried in the dryer considering fire hazard.

- Unwashed laundry items
- Items soiled with oil, acetone, alcohol, fuel oil, kerosene, stain removers, turpentine, paraffin or paraffin removers must be washed in hot water with plenty of detergent before being dried in the dryer.

For this reason especially the items containing the above specified stains must be washed very well, to do this use adequate detergent and choose a high washing temperature.

# Important instructions for safety and environment



## **Below specified laundry or items must not be dried in the dryer due to the fire hazard:**

- Garments or pillows bolstered with rubber foam (latex foam), shower bonnets, water resistant textiles, materials with rubber reinforcement and rubber foam pads.
  - Clothing cleaned with industrial chemicals.
- Items such as lighter, match, coins, metal parts, needle etc. may damage the drum set or may lead to functional problems. Therefore check all the laundry that you will load into your dryer.
- Never stop your dryer before the programme completes. If you must do this, remove all laundry quickly and lay them out to dissipate the heat.



Clothes that are washed inadequately may ignite on their own and even may ignite after drying ends.

- You must provide enough ventilation in order to prevent gases exiting from devices operating with other types of fuels including the naked flame from accumulating in the room due to the back fire effect.



Underwear that contains metal reinforcements should not be dried in the dryer. Dryer may be damaged if metal reinforcements come loose and break off during drying.



Use softeners and similar products in accordance with the instructions of their manufacturers.



Always clean the lint filter before or after each loading. Never operate the dryer without the lint filter installed.

# Important instructions for safety and environment

- Never attempt to repair the dryer by yourself. Do not perform any repair or replacement procedures on the product even if you know or have the ability to perform the required procedure unless it is clearly suggested in the operating instructions or the published service manual. Otherwise, you will be putting your life and others' lives in danger.
- There must not be a lockable, sliding or hinged door that may block the opening of the loading door in the place where your dryer is to be installed.
- Install your dryer at places suitable for home use. (Bathroom, closed balcony, garage etc.)
- Make sure that pets do not enter the dryer. Check the inside of the dryer before operating it.
- Do not lean on the loading door of your dryer when it is open, otherwise it may fall over.
- The lint must not be allowed to accumulate around the tumble dryer
- The tumble dryer is not to be used if industrial chemicals have been used for cleaning.
- Fabric softeners, or similar products, should be used as specified by the fabric softener instructions.
- Exhaust air must not be discharged into a flue which is used for exhausting fumes from appliances burning gas or other fuels.

## 1.2 Mounting over a washing machine

- A fixing device should be used between the two machines when installing the dryer above a washing machine. The fitting device must be installed by the authorized service agent.



# Important instructions for safety and environment

- Total weight of the washing machine and the dryer -with full load- when they are placed on top of each other reaches to approx. 180 kilograms. Place the products on a solid floor that has sufficient load carrying capacity!



Washing machine cannot be placed on the dryer. Pay attention to the above warnings during the installation on your washing machine.

**Installation Table for Washing Machine and Dryer**

Dryer Depth	Washing Machine Depth						
	62 cm	60 cm	54 cm	50 cm	49 cm	45 cm	40 cm
54 cm	Can be installed					Can be installed	Cannot be installed
60 cm	Can be installed					Cannot be installed	

## 1.3 Intended use

- Dryer has been designed for domestic use. It is not suitable for commercial use and it must not be used out of its intended use.
- Use the dryer only for drying laundry that are marked accordingly.
- The manufacturer waives any responsibility arisen from incorrect usage or transportation.
- The service life of the dryer that you purchased is 10 years. During this period, original spare parts will be available to operate the dryer properly.

## 1.4 Child safety

- Packaging materials are dangerous for the children. Keep packaging materials away from children.
- Electrical products are dangerous for the children. Keep children away from the product when it is operating. Do not let them tamper with the dryer. Use the child-proof lock in order to prevent the children to tamper with the dryer.

# Important instructions for safety and environment



Child-proof lock is on the control panel.  
**(See Child lock)**

- Keep loading door closed even when the dryer is not in use.

## 1.5 Compliance with the WEEE regulation and disposing of the waste product

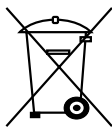

This product complies with EU WEEE Directive (2012/19/EU). This product bears a classification symbol for waste electrical and electronic equipment (WEEE).

This product has been manufactured with high quality parts and materials which can be reused and are suitable for recycling. Do not dispose of the waste product with normal domestic and other wastes at the end of its service life. Take it to the collection center for the recycling of electrical and electronic equipment. Please consult your local authorities to learn about these collection centers.

## 1.6 Compliance with RoHS Directive:

The product you have purchased complies with EU RoHS Directive (2011/65/EU). It does not contain harmful and prohibited materials specified in the Directive.

## 1.7 Package information

Packaging materials of the product are manufactured from recyclable materials in accordance with our National Environment Regulations. Do not dispose of the packaging materials together with the domestic or other wastes. Take them to the packaging material collection points designated by the local authorities.

# Important instructions for safety and environment

## 1.8 Technical Specifications

EN



Height (Min. / Max.)	84,6 cm / 86,6 cm*
Width	59,5 cm
Depth	54 cm
Capacity (max.)	7 kg**
Net weight ( $\pm$ 4 kg)	34 kg
Width	See type label***
Voltage	
Rated power input	

\* Min. height: Height with adjustable feet are closed.

Max. height: Height with adjustable feet are opened maximum.

\*\* Dry laundry weight before washing.

\*\*\* Type label is located behind the loading door.

	Technical specifications of the dryer are subject to specification without notice to improve the quality of the product.
	Figures in this manual are schematic and may not match the product exactly.
	Values stated on markers on the dryer or in the other published documentation accompanying with the dryer are obtained in laboratory in accordance with the relevant standards. Depending on operational and environmental conditions of the dryer, these values may vary.

## 2 Your Dryer

### 2.1 Overview

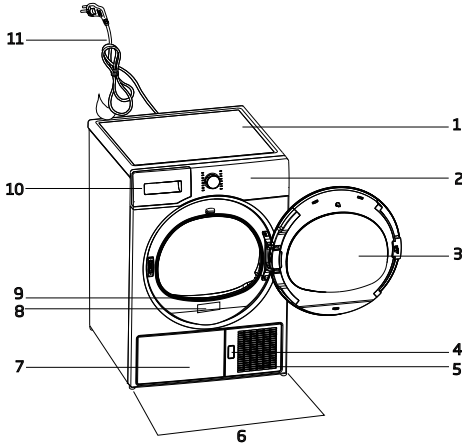

1. Top panel
2. Control panel
3. Loading door
4. Kick plate opening button
5. Ventilation grids
6. Adjustable legs
7. Kick plate
8. Type label
9. Lint filter
10. Water tank drawer
11. Power cord

### 2.2 Package Contents

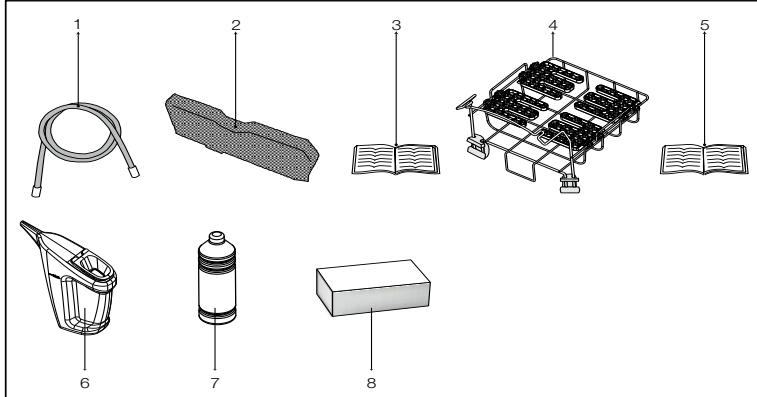

1. Water drain hose \*
2. Filter drawer spare sponge\*
3. User Manual
4. Drying basket\*
5. Drying basket user manual\*
6. Water Filling Container\*
7. Pure Water\*
8. Fragrance Capsules Group\*

\*It can be supplied with your machine depending on its model.

## 3 Installation

Before calling the nearest Authorized Service for the installation of the dryer, ensure that electrical installation and water drain is appropriate referring to the user's manual. If they are not suitable, contact a qualified electrician and technician to make necessary arrangements.



Preparation of the dryer's location as well as the electrical and waste water installations is under customer's responsibility.



Prior to installation, visually check if the dryer has any defects on it. If the dryer is damaged, do not have it installed. Damaged products cause risks for your safety.

### 3.1 Appropriate installation location

Install the dryer on a stable and level surface. Dryer is heavy. Do not move it by yourself.

- Operate your dryer in a well ventilated, dust-free environment.
- The gap between the dryer and the surface should not be reduced by the materials such as carpet, wood and tape.
- Do not cover the ventilation grills of the dryer.
- There must not be a lockable, sliding or hinged door that may block the opening of the loading door in the place where your dryer is to be installed.
- Once the dryer is installed, it should stay at the same place where its connections have been made. When installing the dryer, make sure that its rear wall does not touch anywhere (tap, socket, etc.).
- Place the dryer at least 1 cm away from the edges of other furniture.
- Your dryer can be operated at temperatures between +5°C and +35°C. If the operating conditions fall outside of this range, operation of the dryer will be adversely affected and it can get damaged.
- The rear surface of the tumble dryer shall be placed against a wall.



Do not place the dryer on the power cable.

### 3.2 Removing the transportation safety assembly



Remove the transportation safety assembly before using the dryer for the first time.

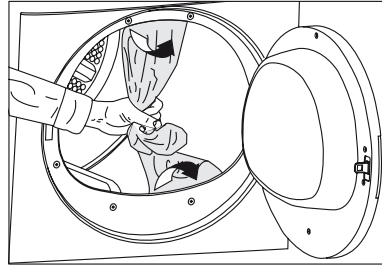

### 3.3 Connecting to the drain

You can directly drain accumulated water through the water drain hose supplied with the product instead of periodically draining the water collected in the water tank.

#### Connecting the water drain hose

- 1-2** Pull hose at the behind of the dryer by hand in order to disconnect it from where it is connected. Do not use any tools to remove the hose.
- 3** Connect one end of the drain hose supplied with the dryer to the connection point from where you removed the hose of the product in previous step.
- 4** Connect the other end of the drain hose directly to the wastewater drain or to the washbasin.

# Installation

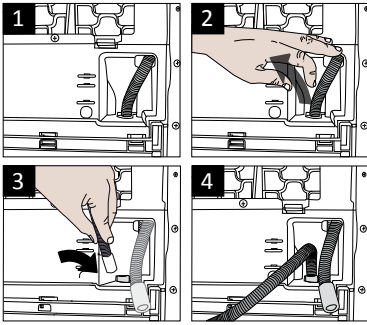

Water drain hose should be attached to a height of maximum 80 cm.



Make sure that the water drain hose is not stepped on and it is not folded between the drain and the machine.



If there is an accessories pack supplied with your product, please see the detailed description.

## 3.4 Adjusting the feet

- Turn the feet to left or right until the dryer stands level and firmly.

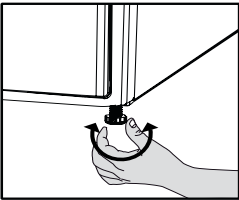

## 3.5 Transportation of the dryer

Drain all water that has remained in the dryer. If direct water drain connection is made, then remove the hose connections.



We recommend carrying the dryer in upright position. If it is not possible to carry the machine in the upright position, we recommend carrying it by tilting towards the right side when looked from the front.





## 3.6 Changing the illumination lamp

In case an illumination lamp is used in your laundry dryer. To change the Bulb/LED used for illumination of your tumble dryer, call your Authorized Service. The lamp(s) used in this appliance is not suitable for household room illumination. The intended purpose of this lamp is to assist the user to place laundry in the tumble dryer in a comfortable way. The lamps used in this appliance have to withstand extreme physical conditions such as vibrations and temperatures above 50 °C

## 4 Preparation

### 4.1 Laundry suitable for drying in the dryer

Always obey the instructions given on the garment tags. Dry only the laundry having a label stating that they are suitable for drying in a dryer and make sure that you select the appropriate programme.

			
Do not dry with dryer	At high temperature	At medium temperature	At low temperature

### 4.2 Laundry not suitable for drying in the dryer



Delicate embroidered fabrics, woollen, silk garments, delicate and valuable fabrics, airtight items and tulle curtains are not suitable for machine drying.

### 4.3 Preparing laundry for drying

- Laundry may be tangled with each other after washing. Separate the laundry items before placing them into the dryer.
- Dry garments having metal accessories such as zippers, inside out.
- Fasten the zippers, hooks and buckles and button sheets.

### 4.4 Things to be done for energy saving

- Spin your laundry at the highest speed possible when washing them. Thus, the drying time is shortened and energy consumption is reduced.
- Sort out the laundry depending on their type and thickness. Dry the same type of laundry together. For example thin kitchen towels and tableclothes dries earlier than thick bathroom towels.
- Follow the instructions in the user manual for programme selection.
- Do not open the loading door of the machine during drying unless necessary. If you must open the loading door, do not keep it open for a long time.

- Do not add wet laundry while the dryer is in operation
- For models with a condenser unit: clean the condenser once in a month or after every 30 operations regularly. .
- For models with heat pump unit: clean the filter drawer periodically when there is a visible accumulation of fluff or when the filter drawer cleaning indicator «» lights up.
- For models with flue unit: comply with the flue connection instructions and clean the flue.
- During the drying process, air the room well where your tumble dryer is operating.

### 4.5 Correct load capacity

Follow the instructions in the "Programme selection and consumption table". Do not load more than the capacity values stated in the table.

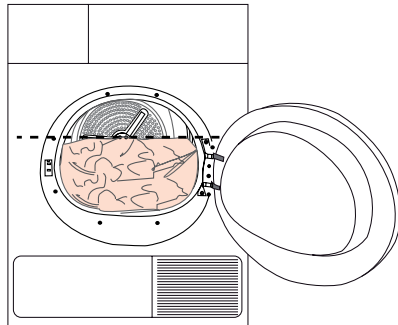

# Preparation

Following weights are given as examples.

Laundry	Approximate weights (g)*
Cotton quilt covers (double)	1500
Cotton quilt covers (single)	1000
Bed sheets (double)	500
Bed sheets (single)	350
Large tablecloths	700
Small tablecloths	250
Tea napkins	100
Bath towels	700
Hand towels	350
Blouses	150
Cotton shirts	300
Shirts	250
Cotton dresses	500
Dresses	350
Jeans	700
Handkerchiefs (10 pieces)	100
T-Shirts	125

\*Dry laundry weight before washing.



## 5 Operating the product

### 5.1 Control Panel

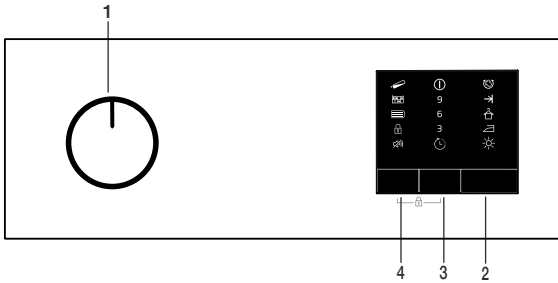

1. On/Off/Program selection button
2. Start/Pause button
3. End Time button
4. Audio warning level button

### 5.2 Symbols

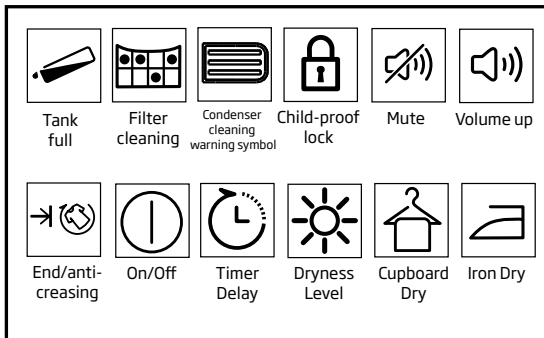

### 5.3 Preparation of drying machine

- Plug the drying machine.
- Open the loading door.
- Place the laundry to the drying machine without jamming them.
- Push and close the loading door.

Select the desired program using the On/Off/Program selection knob, the machine will turn on.



Selecting a program using the On/Off/Program selection button does not mean that the program started. Press the Start / Stand-by button to start the program.



Ensure that no laundry is jammed to the loading door.

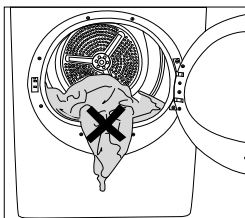

# Operating the product

## 5.4 Programme selection and consumption table

EN				
Programmes	Programme Description	Capacity (kg)	Spin speed in washing machine (rpm)	Drying Time (minutes)
Cotton Iron Dry	You may dry your cotton laundry to be ironed in this programme to have them slightly damp for ease of ironing. (Shirt, T-shirt, tablecloth, etc.)	7	1000	90
Cotton Cupboard Dry	You may dry all your cotton laundry in this programme. (T-shirt, pants, pyjamas, baby clothes, underwear, linen, etc.) You can put your laundry in the wardrobe without ironing.	7 / 3,5	1000	121 / 72
Cotton Cupboard Dry Plus	You may use this programme for extra dryness in thick laundry such as pants, tracksuit. You can put your laundry in the wardrobe without ironing.	7	1000	126
Cotton Extra Dry	You may dry your thick cotton laundry in this programme such as towels, bathrobe, etc. You can put your laundry in the wardrobe without ironing.	7	1000	131
Synthetic Iron Dry	You may dry your synthetic laundry to be ironed in this programme to have them slightly damp for ease of ironing. (Shirt, T-shirt, tablecloth, etc.)	3,5	800	35
Synthetic Cupboard Dry	You may dry all your synthetic laundry in this programme. (Shirt, T-shirt, underwear, tablecloth, etc.) You can put your laundry in the wardrobe without ironing.	3,5	800	48
Sport	You may dry your sports clothes that are appropriate for tumble drying in this programme.	4	1000	92
Freshen up	It just provides airing for 10 minutes without any hot air. You can air the cotton and linen laundry that have been stored for a long time, and eliminate the odour in them.	-	-	10
Time Programmes	You may select from time programmes between 10 and 30 and 60 minutes to achieve the desired drying level at low temperature. In this programme, tumble drier's operation lasts for the set time independently from the dryness of laundry.	-	-	-
Babyprotect	Program used for baby clothing with can be dried approval on the label.	3	1000	80
Jeans	You may dry denim pants, skirts, shirts or jackets in this programme.	4	1200	80

# Operating the product

Gentle Care / Shirts	You may dry your delicate laundry or laundry with hand wash symbol (silk blouses, thin underwear, etc.) at low temperature in this program.	2	600	40
Express Super Short	Dries shirts more delicately and thus causes less wrinkles for easy ironing.	0,5	1200	14
Energy consumption values				
Programs	Capacity (kg)	Spin speed in washing machine (rpm)	Approximate amount of remaining humidity	Energy consumption value kWh
Cotton cupboard dry*	7 / 3,5	1000	60%	4,21 / 2,31
Cotton Iron dry	7	1000	60%	3,25
Synthetic cupboard dry	3,5	800	40%	1,42
Power consumption of the off-mode for the standart cotton programme at full load, PO (W)				0,5
Power consumption of the left-on mode for the standart cotton programme at full load, PL (W)				1,0
	"Cotton cupboard dry programme" used at full and partial load is the standard drying programme to which the information in the label and the fiche relates, that this programme is suitable for drying normal wet cotton laundry and that it is the most efficient programme in terms of energy consumption for cotton.			

\* : Energy Label standard program (EN 61121:2012)

All the values on the chart are identified according to EN 61121:2012 standard. Consumption values may vary from the values in the chart depending on laundry type, wringing speed, ambient conditions and voltage levels.

## 5.5 Auxiliary functions

### Audible warning

Drying machine makes an audible warning when the program is completed. If you don't want it to make an audible warning, press the "Buzzer" button. When you press the Buzzer button, a light will illuminate and no audible warning will be made when the program ends.

 You can select this function before or after the program starts.

### End time

If you prefer to dry your laundry at a later time, you can delay start time of the program up to 3 hours, 6 hours or 9 hours using the Delay function.

Open the loading door and place the laundry. Select the drying program.

Press the End Time selection button and set the delay time you wish. When the End Time button is pressed once, 3 hours delay is selected and the delay indicator will light up. If you press the same button again, 6 hours delay will be selected and when you press for the third time, 9 hours delay will be selected. If you press the End Time button once again, the delay will be cancelled.

After the End Time selection is made, start delayed running for the program selected pressing the "Start/Stand-by" button.

# Operating the product



You can add or remove laundry within end time. At the end of the Time Delay countdown, the Time Delay warning indicator turns off and drying begins

## Changing the end time

If you want to change the duration during the countdown:

Cancel the program by turning the On/Off/Program selection knob. Select the program you want and repeat the End Time selection process.

## Cancelling the end time function

If you want to cancel the end time countdown and start the program immediately:

Cancel the program by turning the On/Off/Program selection knob. Select the program you want and press the Start/Stand-by button.

## 5.6 Warning indicators



Warning indicators may vary depending on the model of your dryer.

## Filter cleaning

When the program is completed, the warning indicator for filter cleaning turns on.

## Water tank

When the program is completed, the warning indicator to empty the water tank turns on. If the water tank fills up while the program continues, the warning indicator starts flashing and the machine goes into stand-by. In this case, empty the water tank and start the program by pressing the Start / Stand-by button. Warning indicator turns off and program resumes.

## Condenser

Clean the condenser periodically when there is a visible accumulation of fluff or when the condenser cleaning indicator «» lights up, if any.

## 5.7 Starting the program

Press the Start/Stand-by button to start the program.

Drying indicator will light up, indicating that the program has started.

## 5.8 Child Lock

The drying machine has a child lock which prevents the program flow from being interrupted when the buttons are pressed during a program. When the child lock is activated, all buttons on the panel except the On/Off/Program selection knob are deactivated.

Press the End Time and Buzzer buttons simultaneously for 3 buttons to activate the child lock.

The child lock has to be deactivated to be able to start a new program after the current program is finished or to be able to interfere with the program. To deactivate the child lock, keep the same buttons pressed for 3 seconds.



When the child lock is activated, the child lock warning indicator on the screen turns on.



Child lock deactivates when the drying machine is turned off and on by the On/Off/Cancel knob.

When the child lock is active:

When the drying machine runs, or in stand-by state, the indicator symbols won't change upon changing the position of the program selection knob.



When the drying machine runs and the child lock is active, it beeps twice when the program selection knob is turned. If the child lock is deactivated without returning the program selection knob to its previous position, program will terminate due to the change in the program selection knob position.

## Operating the product

### 5.9 Changing the program after it is started

You can change the program you selected to dry your laundry with a different program after the drying machine starts running

- For instance, select Extra Dry program by turning the On/Off/Program selection knob to select Extra Dry instead of Iron Dry.
- Press the Start/Stand-by button to start the program.

### Adding and removing clothes during stand-by

If you want to add or remove clothes to/from the drying machine after the drying program starts:

- Press the Start/Stand-by button to put the drying machine in Stand-by state. The drying operation stops.
- Open the loading door while in Stand-by state, and close the door after you remove or add laundry.
- Press the Start/Stand-by button to start the program.



Adding laundry after the drying operation starts may cause the dried laundry inside the machine to mix with wet laundry and leave the laundry damp at the end of operation.



Adding or removing laundry during drying may be repeated as many times as you wish. But this operation continuously interrupts the drying operation, and thus increases program duration and energy consumption. So, it is recommended to add laundry before the program starts.



If a new program is selected by turning the program selection knob while the drying machine is in stand-by, the running program terminates.



Do not touch the inner surface of the drum while adding or removing clothes during a continuing program. The drum surface is hot.

### 5.10 Cancelling the program

If you want to cancel the program and terminate the drying operation for any reason after the drying machine starts running, turn the On/Off/Cancel knob, the program will be cancelled.



The inside of the drying machine shall be extremely hot when you cancel the program during machine operation, so run the refresh program to allow it to cool down.

### 5.11 End of program

When the program ends, the Fibre Filter Cleaning and Water Tank warning symbols on the program observation indicator turn on. Loading door may be opened and the dryer machine becomes ready for another run. Bring the On/Off/Program selection knob to On/Off position to turn the drying machine off.



If the laundry is not removed after the program is completed, the wrinkle prevention function activates for 2 hours to prevent the laundry inside the machine to get wrinkled. The program tumbles the laundry with 10-minute intervals to prevent them from wrinkling.

## 6 Maintenance and cleaning

Service life of the product extends and frequently faced problems decrease if cleaned at regular intervals.



Unplug the product from the mains during any maintenance and cleaning works (control panel, body, etc.).

### 6.1 Lint Filter / Loading Door Inner Surface

Lint and fiber released from the laundry to the air during the drying cycle are collected in the Lint Filter.



Always clean the lint filter and the inner surfaces of the loading door after each drying process.



You can clean the lint filter housing with a vacuum cleaner.

To clean the lint filter:

1. Open the loading door.
2. Remove the lint filter by pulling it up and open the lint filter.
3. Clean lint, fiber, and cotton raveling by hand or with a soft piece of cloth.
4. Close the lint filter and place it back into its housing.

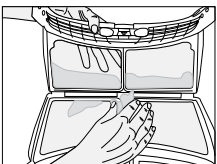
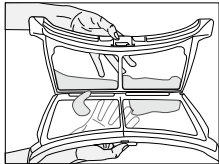
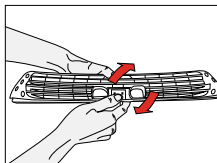
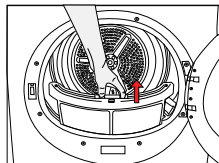

A layer can build up on the filter pores that can cause clogging of the filter after using the machine for a while. Wash the lint filter with warm water to remove the layer that builds up on the lint filter surface. Dry the lint filter completely before reinstalling it.

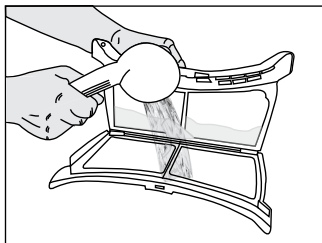

Clean the entire inner surface of the loading door and loading door gasket.

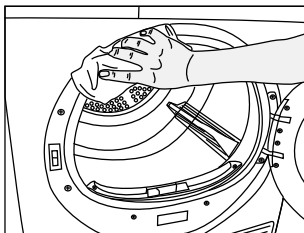
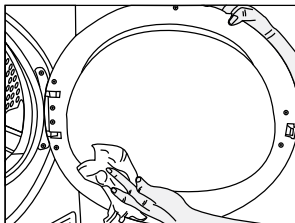

# Maintenance and cleaning

## 6.2 Cleaning the sensors

There are dampness sensors in the machine that detect whether the laundry is dry or not. To clean the sensors:

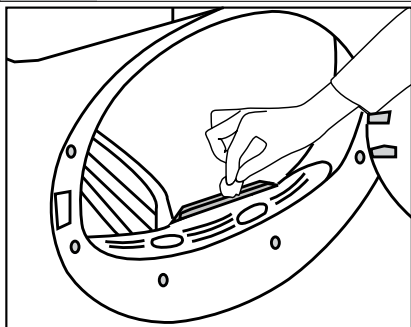

1. Open the loading door of the machine.
2. Allow the machine to cool down if it is still hot due to the drying process.
3. Wipe the metal surfaces of the sensor with a soft cloth, dampened with vinegar and dry them.

	Clean metal surfaces of the sensors 4 times a year.
	Do not use metal tools when cleaning metal surfaces of the sensors.
	<b>CAUTION:</b> Never use solvents, cleaning agents or similar substances for cleaning due to the risk of fire and explosion!



## 6.3 Draining the water tank

Dampness of the laundry is removed and condensed during drying process and the water that arise accumulates in the water tank. Drain the water tank after each drying cycle.

	Condensed water is not drinkable!
	<b>CAUTION:</b> Never remove the water tank when the program is running!

If you forget to drain the water tank, the machine will stop during the subsequent drying cycles when the water tank is full and the Water Tank warning symbol will flash. If this is the case, drain the water tank and press **Start / Pause** button to resume the drying cycle.

To drain the water tank:

1. Remove the water tank in the drawer or container carefully.

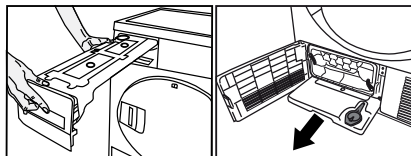

2. Drain the water in the tank.

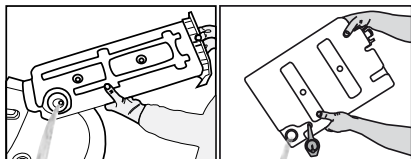

3. If there is lint accumulation in the funnel of the water tank, clean it under running water.
4. Place the water tank into its seat.

# Maintenance and cleaning

## 6.4 For the condenser;

Hot and humid air in the condenser is cooled with the cold air from the room. Thus, the humid air circulating in your dryer is condensed and then pumped into the tank.



Clean the condenser after every 30 drying cycles or once a month.

To clean the condenser:

1. If a drying process has been carried out, open the door of the machine and wait until it cools down.

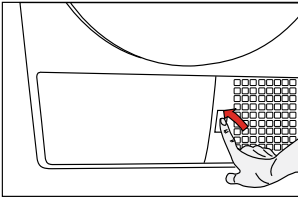

2. Unlock the 2 condenser locks after opening the kick plate.

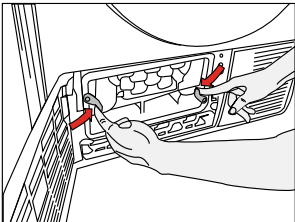

3. Pull out the condenser.

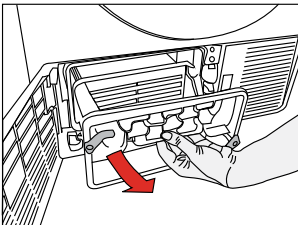

4. Clean the condenser by applying pressurized water with a shower armature and wait until the water drains.

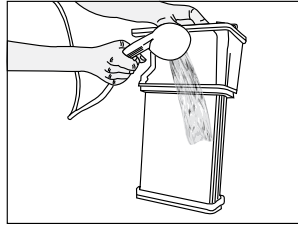

5. Place the condenser in its housing. Fasten the 2 locks and make sure that they are seated securely.

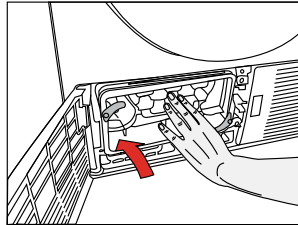

6. Close the kick plate cover.

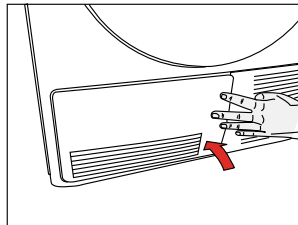



## 7 Troubleshooting

### Drying operation takes too long.

- Fibre filter pores might be clogged. >>> Wash the filter with warm water.
- Filter drawer might be clogged. >>> Clean the sponge and filter cloth (if any) in the filter drawer. (for the products with a heat pump)
- The condenser might be blocked. >>> Wash the condenser.(for the products with a condenser )
- The ventilation grills in front of the machine may be closed. >>> Remove any objects in front of the ventilation grills that blocks air.
- Ventilation may be inadequate because the area the machine is installed in is too small. >>> Open the door or windows to prevent the room temperature from rising very high.
- A lime layer may have accumulated on the humidity sensor. >>> Clean the humidity sensor.
- Excessive amount of laundry might be loaded. >>> Do not load the drying machine excessively.
- Laundry might not have been wrung adequately. >>> Perform a higher speed wringing on the washing machine.

### Clothes come out damp after drying.

- A program not suitable for the laundry type may have been used.>>> Check the maintenance labels on the clothes and select a program suitable for the clothes' type or use time programs as extra.
- Fibre filter pores might be clogged. >>> Wash the filter with warm water.
- The condenser might be blocked. >>> Wash the condenser. (for the products with a condenser)
- Filter drawer might be clogged. >>> Clean the sponge and filter cloth (if any) in the filter drawer.(For the products with a heat pump)
- Excessive amount of laundry might be loaded. >>> Do not load the drying machine excessively.
- Laundry might not have been wrung adequately. >>> Perform a higher speed wringing on the washing machine.

### Drying machine does not turn on or program cannot be started. Drying machine does not run after it is configured.

- Power plug might be unplugged. >>> Make sure the power cord is plugged in.
- Loading door might be open. >>> Ensure that the loading door is properly closed.
- A program might not be set or Start/Stand-by button might not be pressed. >>> Check that the program is set and it is not in Stand-by position.
- Child lock may be activated. >>> Turn off the child lock.

### Program terminated prematurely for no reason.

- Loading door might not be closed completely. >>> Ensure that the loading door is properly closed.
- There might be a power outage. >>> Press the Start/Stand-by button to start the program.
- Water tank may be full. >>> Empty the water tank.

# Troubleshooting

Clothes have shrunk, hardened or spoiled.

- A program not suitable with the laundry type might have been used. >>> Check the maintenance labels on the clothes and select a program suitable for the clothes.

The lighting inside the drying machine does not turn on. (For models with a lamp)

- Drying machine might not be turned on with the On/Off button or program might not be selected for machines without an On/Off button. >>> Make sure that the drying machine is turned on.
- Lamp might be malfunctioning. >>> Contact Authorized Service to replace the lamp.

Filter cleaning warning symbol/LED is on/flashing.

- Fibre filter might not be cleaned. >>> Clean the filter.
- The filter slot might be clogged with lints. >>> Clean the filter slot.
- A layer of fluff might have accumulated clogging up the lint filter pores. >>> Wash the filter with warm water.
- The condenser might be blocked. >>> Wash the condenser.

Water drips from the loading door.

- Fibres might have gathered on the inner sides of the loading door and the loading door gasket. >>> Clean the inner surfaces of the loading door and the loading door gasket surfaces.

Loading door opens by itself.

- Loading door might not be closed completely. >>> Push the loading door until the closing sound is heard.

Water tank warning symbol / led is on/flashing.

- Water tank may be full. >>> Empty the water tank.
- Water discharge hose might have collapsed. >>> If the product is connected directly to the water drain check the water discharge hose.

Steam symbol is flashing.(For the products with a steam function)

- Steam tank may be empty => Fill the steam tank with distilled or condensed water.

Steam programs do not start (For the products with a steam function)

- Steam tank may be empty, steam tank warning icon may light up on the screen => Fill the steam tank until the steam icon goes off.

Wrinkles are not removed with wrinkle removing program. (For the products with a steam function)

- Excess amount of laundry may have been placed => Place specified amount of laundry.
- Steam application time may be selected in low level => Choose a program with high amount of steam.
- After completion of the program, the laundry may have stayed in the machine for a long time => Take the laundry out as soon as the program finishes, and hang it out.

Laundry odour not lessened with the odour removal program.(For the products with an odour removal program)

- Excess amount of laundry may have been placed => Place specified amount of laundry.
- Steam application time may be selected in low level => Choose a program with high amount of steam.



If the problem persists after following the instructions in this section, contact your vendor or an Authorized Service. Never try to repair your product yourself.

## 8 Service

Please keep your purchase receipt or other proof of purchase in a safe place; you will need to have it should the product require attention under guarantee.

You should also complete the details below; it will help us assist you when requesting service. (The model number is printed on the Instruction Booklet and the serial number is printed on the Rating Label affixed to the appliance)

Model No:

Serial No:

Retailer:

Date of purchase:

### 8.1 Republic of Ireland

All Refrigeration, 01 862 3411

All Cookers

Washing Machines & Dryers, Tumble Dryers

Dishwashers

Before requesting service please check the trouble-shooting guide in the Operating Instructions as a charge may be levied where no fault is found even though your product may still be under guarantee.

### 8.2 Service once the manufacturers guarantee has expired.

If you have purchased an extended guarantee please refer to the instructions contained within the extended guarantee agreement document. Otherwise please call the appropriate number above where service can be obtained at a charge.

Should you experience any difficulty in obtaining service please contact the Customer Help-Line.

Tel: 0845 600 4911

For service under guarantee simply telephone the appropriate number below.

### 8.3 UK Mainland & Northern Ireland

Fridges & Freezers 0345 600 4903 or 0845 600 4903

Electric Cookers 0345 600 4902 or 0845 600 4902

Gas & Dual Fuel Cookers

0345 600 4905 or 0845 600 4905

Washing Machines & Tumble Dryers

0345 600 4906 or 0845 600 4906

## 9 Electrical Connection

Make sure that you have an earthed power outlet socket rated at 13 amps (minimum).

### 9.1 Attention!

When installed, the socket must be reachable after installation, or a separate switch (which can disconnect the two poles) must be used in the installation. Check for suitability. For a permanent connection, a master switch with at least 3mm contact clearance and minimum 13 A rating must be used.

### 9.2 Electrical requirements

Before you insert the plug into the wall socket make sure that the voltage and the frequency shown in the rating label corresponds to your electricity supply. We recommend that this appliance be connected to the mains supply via a suitable switched and fused socket in a readily accessible position. Should the mains lead of the appliance become damaged or need replacing at any time, it must be replaced by a special purpose made mains lead which can only be obtained from a Authorised Service Agent.



Do not operate without the top cover fitted. Risk of injury.



Important

### 9.3 Fitting a different plug

As the colours of the wires in the mains lead of this appliance may not correspond with the coloured markings identifying the terminals on your plug, proceed as follows:

- 1 Connect the green - yellow or green (earth) wire to the terminal in the plug marked 'E' or with the symbol or coloured green and yellow or green.
- 2 Connect the blue (neutral) wire to the terminal in the plug marked 'N' or coloured black.
- 3 Connect the brown (live) wire to the terminal in the plug marked 'L' or coloured red.

With the alternative plugs a 13A fuse must be fitted either in the plug or adaptor or in the main fuse box. If in doubt contact a qualified electrician.



Warning

This appliance must be earthed. If the fitted moulded plug is not suitable for your socket, then the plug should be cut off and an appropriate plug fitted. The moulded plug on this appliance incorporates a 13A fuse. Should the fuse need to be replaced an ASTA approved BS1362 fuse of the same rating must be used. Do not forget to refit the fuse cover. In the event of losing the fuse cover, the plug must not be used until a replacement fuse cover has been fitted. Colour of the replacement fuse cover must be the same colour as that visible on the pin face of the plug. Fuse covers are available from any good electrical store.

In order to avoid hazards, damaged supply cord should be replaced by the manufacturer, its service agent or similarly qualified people. Built-under installation  
This appliance can be installed under a worktop.

Green and yellow  
or green  
⏏

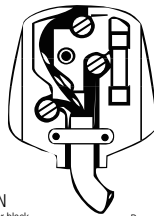

N  
Blue or black

L  
Brown or red

### 9.4 Washer/dryer combination

Do not stack washing machine on top of the tumble dryer. This would damage both appliances and guarantees would become void. It is also unsafe to stack an appliance on top of another without using a suitable and approved stacking kit obtained from the manufacturer of the appliances.

- A special stacking kit is required as an optional extra please contact customer service.

## PRODUCT FICHE

### Complying Commission Delegated Regulation (EU) No 392/2012

Supplier name or trademark		BEKO
Model name		DTGC7000 W / DTGC7000 S / DTGC7000 B
Rated capacity (kg)		7
Type of Tumble Dryer	Air Vented	-
	Condenser	•
Energy efficiency class <sup>(1)</sup>		B
Annual Energy Consumption (kWh) <sup>(2)</sup>		504
Type of Control	Automatic	•
	Non-automatic	-
Energy consumption of the standard cotton programme at full load (kWh)		4,21
Energy consumption of the standard cotton programme at partial load (kWh)		2,31
Power consumption of the off-mode for the standard cotton programme at full load, P <sub>0</sub> (W)		0,5
Power consumption of the left-on mode for the standard cotton programme at full load, P <sub>L</sub> (W)		1,0
The duration of the left on mode (min)		30
Standard cotton programme <sup>(3)</sup>		-
Programme time of the standard cotton programme at full load, T <sub>dry</sub> (min)		121
Programme time of the standard cotton programme at partial load, T <sub>dry1/2</sub> (min)		72
Weighted programme time of the standard cotton programme at full and partial load (T <sub>w</sub> )		93
Condensation efficiency class <sup>(4)</sup>		B
Average condensation efficiency of the standard cotton programme at full load, C <sub>dry</sub>		81%
Average condensation efficiency of the standard cotton programme at partial load, C <sub>dry1/2</sub>		81%
Weighted condensation efficiency of the standard cotton programme at full and partial load, C <sub>t</sub>		81%
Sound power level for the standard cotton programme at full load <sup>(5)</sup>		65
Built-in		-

• : Yes - : No

(1) Scale from A+++ (most efficient) to D (least efficient)

(2) Energy consumption based on 160 drying cycles of the standard cotton programme at full and partial load, and the consumption of the low-power modes. Actual energy consumption per cycle will depend on how the appliance is used.

(3) "Cotton cupboard dry programme" used at full and partial load is the standard drying programme to which the information in the label and the fiche relates, that this programme is suitable for drying normal wet cotton laundry and that it is the most efficient programme in terms of energy consumption for cotton

(4) Scale from G (least efficient) to A (most efficient)

(5) Weighted average value — L<sub>WA</sub> expressed in dB(A) re 1 pW





## Guarantee

Your new product is guaranteed against the cost of breakdown repairs for twelve months from the date of the original purchase.

### What is covered?

- Repairs necessary as a result of faulty materials, defective components or manufacturing defect.
- The cost of functional replacement parts, but excluding consumable items.
- The labour costs of a approved repairer to carry out the repair.

### What is not covered?

- Transit, delivery or accidental damage or misuse and abuse.
- Cabinet or appearance parts, including knobs, flaps, handles or container lids.
- Accessories or consumable items including but not limited to, ice trays, scrapers, cutlery baskets, filters and light bulbs.
- Repairs required as a result of unauthorised repair or inexpert installation that fails to meet the requirements contained in the user instruction book.
- Repairs to products used on commercial or non-residential household premises.
- Loss of frozen food in freezers or fridge/freezers. (Food loss insurance is often included within your household contents insurance policy, or may be available separately from your retailer).

### Important notes

- Your product is designed and built for domestic household use only.
- The guarantee will be void if the product is installed or used in commercial or non-residential domestic household premises.
- The product must be correctly installed, located and operated in accordance with the instructions contained in the User Instructions Booklet provided.
- Professional installation by a qualified Electrical Domestic Appliance Installer is recommended for all Washing Machines, Tumble Dryers, Dishwashers, Dryers and Electric Cookers
- Gas Cookers must only be installed by a Gas safe registered Gas Installer.
- The guarantee is given only within the boundaries of the United Kingdom and the Republic of Ireland.
- The guarantee is applicable only to new products and is not transferable if the product is resold.
- Disclaims any liability for incidental or consequential damages.
- The guarantee does not in anyway diminish your statutory or legal rights.

Beko plc, Beko House, 1 Greenhill Crescent, Watford, WD18 8QU

Tel: 0845 6004911

Email: [service@beko.co.uk](mailto:service@beko.co.uk)

Fax: 0845 6004922

[www.beko.co.uk](http://www.beko.co.uk)