



CONTENTS

1. SAFETY INFORMATION.....	2
2. SAFETY INSTRUCTIONS.....	4
3. PRODUCT DESCRIPTION.....	6
4. CONTROL PANEL.....	7
5. PROGRAMMES.....	7
6. DAILY USE.....	9
7. HINTS AND TIPS.....	12
8. CARE AND CLEANING.....	14
9. TROUBLESHOOTING.....	15
10. TECHNICAL DATA.....	17
11. ENVIRONMENTAL CONCERNS.....	17

WE'RE THINKING OF YOU

Thank you for purchasing an Electrolux appliance. You've chosen a product that brings with it decades of professional experience and innovation. Ingenious and stylish, it has been designed with you in mind. So whenever you use it, you can be safe in the knowledge that you'll get great results every time.

Welcome to Electrolux.

Visit our website to:



Get usage advice, brochures, trouble shooter, service and repair information:
www.electrolux.com/support



Register your product for better service:
www.registerelectrolux.com



Buy Accessories, Consumables and Original spare parts for your appliance:
www.electrolux.com/shop

CUSTOMER CARE AND SERVICE

Always use original spare parts.

When contacting our Authorised Service Centre, ensure that you have the following data available: Model, PNC, Serial Number.

The information can be found on the rating plate.

 Warning / Caution-Safety information

 General information and tips

 Environmental information

Subject to change without notice.

1. SAFETY INFORMATION

Before the installation and use of the appliance, carefully read the supplied instructions. The manufacturer is not responsible for any injuries or damage that are the result

of incorrect installation or usage. Always keep the instructions in a safe and accessible location for future reference.

1.1 Children and vulnerable people safety

- This appliance can be used by children aged from 8 years and above and persons with reduced physical, sensory or mental capabilities or lack of experience and knowledge if they have been given supervision or instruction concerning the use of the appliance in a safe way and understand the hazards involved.
- Children between 3 and 8 years of age and persons with very extensive and complex disabilities shall be kept away from the appliance unless continuously supervised.
- Children of less than 3 years of age should be kept away from the appliance unless continuously supervised.
- Children should be supervised to ensure that they do not play with the appliance.
- Keep detergents away from children.
- Keep children and pets away from the appliance when the door is open.
- Children shall not carry out cleaning and user maintenance of the appliance without supervision.

1.2 General Safety

- This appliance is for cleaning household-type dishes and tableware only.
- This appliance is designed for single household domestic use in an indoor environment.
- This appliance may be used in, offices, hotel guest rooms, bed & breakfast guest rooms, farm guest houses and other similar accommodation where such use does not exceed (average) domestic usage levels.
- Do not change the specification of this appliance.

- The operating water pressure (minimum and maximum) must be between 0.4 (0.04) / 10 (1) bar (MPa)
- Follow the maximum number of 6 place settings.
- If the supply cord is damaged, it must be replaced by the manufacturer, its Authorised Service Centre or similarly qualified persons in order to avoid a hazard.
- **WARNING:** Knives and other utensils with sharp points must be loaded in the basket with their points down or placed in a horizontal position.
- Do not leave the appliance with the open door unattended to avoid stepping accidentally onto it.
- Before any maintenance operation, deactivate the appliance and disconnect the mains plug from the socket.
- Do not use high pressure water sprays and/or steam to clean the appliance.
- If the appliance has ventilation openings in the base, they must not be covered e.g. by a carpet.
- The appliance is to be connected to the water mains using the new supplied hose-sets. Old hose sets must not be reused.

2. SAFETY INSTRUCTIONS

2.1 Installation



WARNING!

Only a qualified person must install this appliance.

- Remove all the packaging.
- Do not install or use a damaged appliance.
- Follow the installation instructions supplied with the appliance.
- Always take care when moving the appliance as it is heavy. Always use safety gloves and enclosed footwear.
- Do not install or use the appliance where the temperature is less than 0 °C.
- Install the appliance in a safe and suitable place that meets installation requirements.

- Do not use the appliance before installing it in the built-in structure due to safety manner.



www.youtube.com/electrolux
www.youtube.com/aeg

How to install your AEG/Electrolux
 45 cm compact dishwasher
 column installation



2.2 Electrical connection



WARNING!

Risk of fire and electric shock.

- Warning: this appliance is designed to be installed / connected to a grounding connection in the building.

- Make sure that the parameters on the rating plate are compatible with the electrical ratings of the mains power supply.
- Always use a correctly installed shockproof socket.
- Do not use multi-plug adapters and extension cables.
- Make sure not to cause damage to the mains plug and to the mains cable. Should the mains cable need to be replaced, this must be carried out by our Authorised Service Centre.
- Connect the mains plug to the mains socket only at the end of the installation. Make sure that there is access to the mains plug after the installation.
- Do not pull the mains cable to disconnect the appliance. Always pull the mains plug.
- This appliance is fitted with a 13 A mains plug. If it is necessary to change the mains plug fuse, use only a 13 A ASTA (BS 1362) fuse (UK and Ireland only).
- Do not drink and play with the water in the appliance.
- Do not remove the dishes from the appliance until the programme is complete. Some detergent may remain on the dishes.
- Do not store items or apply pressure on the open door of the appliance.
- The appliance can release hot steam if you open the door while a programme operates.

2.5 Service

- To repair the appliance contact the Authorised Service Centre. Use original spare parts only.
 - Please note that self-repair or non-professional repair can have safety consequences and might void the guarantee.
 - The following spare parts will be available for 7 years after the model has been discontinued: motor, circulation and drain pump, heaters and heating elements, including heat pumps, piping and related equipment including hoses, valves, filters and aquastops, structural and interior parts related to door assemblies, printed circuit boards, electronic displays, pressure switches, thermostats and sensors, software and firmware including reset software. Please note that some of these spare parts are only available to professional repairers, and that not all spare parts are relevant for all models.
 - The following spare parts will be available for 10 years after the model has been discontinued: door hinge and seals, other seals, spray arms, drain filters, interior racks and plastic peripherals such as baskets and lids.
 - Concerning the lamp(s) inside this product and spare part lamps sold separately: These lamps are intended to withstand extreme physical conditions in household appliances, such as temperature, vibration, humidity, or are intended to signal information about the operational status of the appliance. They are not intended to be used in other
- ## 2.3 Water connection
- Do not cause damage to the water hoses.
 - Before connection to new pipes, pipes not used for a long time, where repair work has been carried out or new devices fitted (water meters, etc.), let the water flow until it is clean and clear.
 - Ensure that there are no visible water leaks during and after the first use of the appliance.
 - If the water inlet hose is damaged, immediately close the water tap and disconnect the mains plug from the mains socket. Contact the Authorised Service Centre to replace the water inlet hose.
- ## 2.4 Use
- Do not put flammable products or items that are wet with flammable products in, near or on the appliance.
 - Dishwasher detergents are dangerous. Follow the safety instructions on the detergent packaging.

applications and are not suitable for household room illumination.

2.6 Disposal



WARNING!
Risk of injury or suffocation.

- Disconnect the appliance from the mains supply.
- Cut off the mains cable and discard it.
- Remove the door catch to prevent children and pets to get closed in the appliance.

3. PRODUCT DESCRIPTION

3.1 General overview

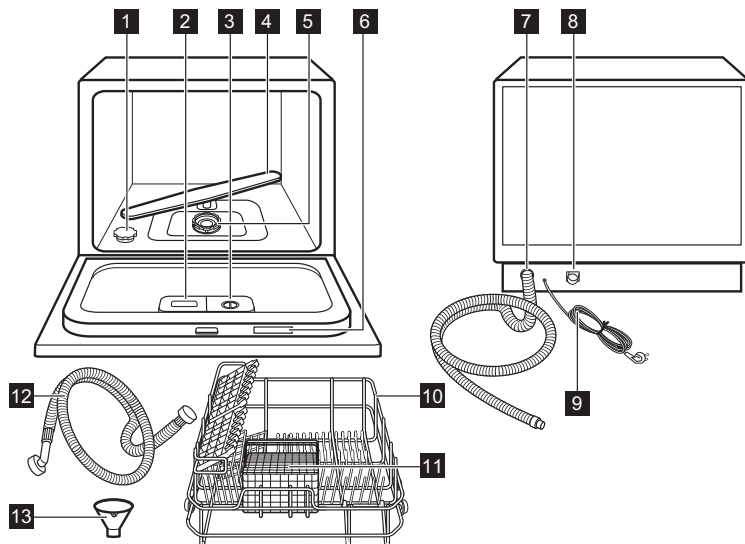

- 1** Salt container
- 2** Detergent dispenser
- 3** Rinse aid dispenser
- 4** Spray arm
- 5** Filters
- 6** Rating plate
- 7** Drain hose

- 8** Inlet hose connection
- 9** Mains cable
- 10** Basket
- 11** Cutlery basket
- 12** Inlet hose
- 13** Funnel

4. CONTROL PANEL

4.1 Control panel

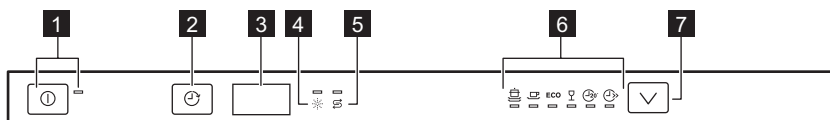

- | | |
|------------------------------|-------------------------------|
| 1 On / Off button | 5 Salt indicator |
| 2 Delay start button | 6 Programme indicators |
| 3 Display | 7 Programme button |
| 4 Rinse aid indicator | |



4.2 Indicators

Indicator	Description
	It is on when the rinse aid dispenser needs refilling. It is always off while the programme operates.
	It is on when the salt container needs refilling. It is always off while the programme operates.

5. PROGRAMMES





5.1 Programme overview

Programme	Degree of soil Type of load	Programme phases	Detergent pre-wash / main wash (g)	Rinse aid
	Heavy, dried-on soiling, pans, pots, casserole dishes	<ul style="list-style-type: none"> Pre-wash 50 °C Dishwash 70 °C Rinse 70 °C Drying 	3 / 15	✓
	Normal soiling, pots, plates, glasses, pans	<ul style="list-style-type: none"> Pre-wash Dishwash 60 °C Rinse 70 °C Drying 	3 / 15	✓
ECO 1)	Normal soiling, crockery, cutlery	<ul style="list-style-type: none"> Pre-wash Dishwash 45 °C Rinse 65 °C Drying 	- / 14	✓

Programme	Degree of soil Type of load	Programme phases	Detergent pre-wash / main wash (g)	Rinse aid
	Normal or light soiling, glasses, crystal, fine china	<ul style="list-style-type: none"> Dishwash 45 °C Rinse 60 °C Drying 	- / 18	✓
	Fresh soiling, coffee cup, glasses	<ul style="list-style-type: none"> Dishwash 45 °C 	- / 15	✗
	Light soiling, all types of dish load	<ul style="list-style-type: none"> Dishwash 40 °C Rinse 	- / 18	✓

1) This programme offers the most efficient use of water and energy consumption for crockery and cutlery with normal soil. This is the standard programme for test institutes. This programme is used to assess compliance with the Ecodesign Commission Regulation (EU) 2019/2022.

5.2 Consumption values

Programme 1)2)	Duration (min)	Energy (kWh)	Water (l)
	140	1.20	9.6
	120	1.05	7.7
ECO	230	0.613	6.5
	75	0.65	5.8
	20	0.39	7.0
	90	1.10	6.6

1) The pressure and the temperature of the water, the variations of the mains supply, the options, the quantity of dishes and the degree of soil can change the values.

2) The values for programmes other than ECO are indicative only.

5.3 Information for test institutes

To receive the necessary information for conducting performance tests (e.g. according to: EN60436), send an email to:

info.test@dishwasher-production.com

In your request, include the product number code (PNC) from the rating plate.

For any other questions regarding your dishwasher, refer to the service book provided with your appliance.

5.4 Before starting a programme

Before you start the selected programme, make sure that:

- The filters are clean and correctly installed.
- The cap of the salt container is tight.
- The spray arms are not clogged.
- There is enough salt and rinse aid (unless you use multi-tablets).
- The arrangement of the items in the baskets is correct.

- The programme is suitable to the type of load and the degree of soil.
- The correct quantity of detergent is used.

5.5 Using a programme

1. Open the appliance door.
2. Open the water tap.
3. Press the On / Off button to activate the appliance.

The On / Off indicator comes on.

4. Press Programme button until the indicator of the selected programme comes on.
5. Close the appliance door. The programme starts automatically after 10 seconds.

When the programme is completed, an intermittent acoustic signal sounds for approximately 8 seconds.

6. Press On / Off button to deactivate the appliance.
7. Close the water tap.

Wait until the dishes are cold before you remove them from the appliance.



There can be water on the sides and the door of the appliance.

5.6 Cancelling a programme

Press and hold Programme button for 3 seconds.

The appliance comes back to its initial settings.



Make sure that there is detergent in the detergent dispenser before you start a new programme.

5.7 Interrupting a programme

1. Open the appliance door. The appliance stops.
2. Close the appliance door.

The programme continues from the point of interruption.

5.8 Starting a programme with Delay start

1. Open the water tap.
2. Press the On / Off button to activate the appliance.

The On / Off indicator comes on.

3. Set a programme.
4. Press Delay start button to delay start of a programme by up to 24 hours.
5. Close the door to start the countdown.

When the countdown is completed, the programme starts automatically.

5.9 Cancelling Delay start

1. Open the appliance door.
2. Press Delay start button until 0 comes on.
3. Close the appliance door. The programme starts automatically.

6. DAILY USE

6.1 Use of the appliance

1. Fill the salt container with salt for dishwashers.
2. Fill the rinse aid dispenser with rinse aid.
3. Load the basket.
4. Open the water tap.
5. Set the correct programme for the type of load and the degree of soil.
6. Add the detergent.
7. Start the programme.

6.2 Filling the salt container



CAUTION!

Use only salt designed for dishwashers.

1. Turn the cap of the salt container counterclockwise and remove it.
2. Put 1 litre of water in the salt container (Only for the first time).
3. Use the funnel to fill the salt container with dishwasher salt.

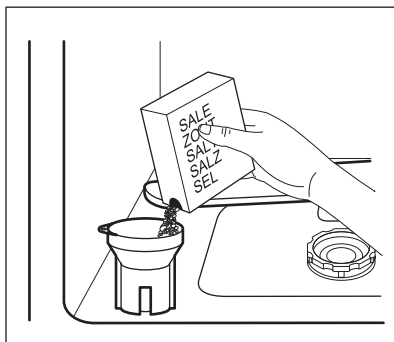

4. Remove the salt around the opening of the salt container.
5. Turn the cap of the salt container clockwise to close the salt container.



Water and salt can come out from the salt container when you fill it, which causes corrosion. To prevent it, start a programme immediately after filling the salt container.

Water hardness

German degrees (°dH)	French degrees (°fH)	mmol/l	Clarke degrees	Setting on the water softener	Setting indication
0 - 5	0 - 9	0.0 - 0.9	0 - 7	1	H1
6 - 11	10 - 19	1.0 - 2.0	8 - 14	2	H2
12 - 17	20 - 30	2.1 - 3.0	15 - 21	3	H3
18 - 22	31 - 39	3.1 - 4.0	22 - 27	4 1)	H4
23 - 34	40 - 60	4.1 - 6.1	28 - 42	5	H5
35 - 45	61 - 80	6.2 - 8.0	43 - 56	6	H6

1) Factory setting.

Regardless of the type of detergent used, set the proper water hardness level to keep the salt refill indicator active.



Multi-tabs containing salt are not effective enough to soften hard water.

Regeneration process

For the correct water softener operation, the resin of the softener device needs to be regenerated regularly. This process is

6.3 The water softener

The water softener removes minerals from the water supply, which would have a detrimental effect on the washing results and on the appliance.

The higher the content of these minerals, the harder your water is. Water hardness is measured in equivalent scales.

The water softener should be adjusted according to the hardness of the water in your area. Your local water authority can advise you on the hardness of the water in your area. Set the right level of the water softener to assure good washing results.

automatic and is the part of the normal dishwasher operation.

Water softener level	Regeneration frequency
1	off
2	every 10 cycles
3	every 5 cycles
4	every 3 cycles

Water softener level	Regeneration frequency
5	every 2 cycles
6	every cycle

Regeneration and softener rinse takes place in the drying phase and ends with a complete drain. This activity lasts around three minutes, but it does not impact the overall cycle time. This activity increases the total water consumption of a programme by additional 1 l and the total energy consumption of a programme by additional 0.3 Wh.

- i** All the consumption values mentioned in this section are determined in line with the currently applicable standard in laboratory conditions with water hardness 2.5mmol/L (water softener: level 3) according to the regulation: 2019/2022 regulation. The pressure and the temperature of water as well as the variations of the mains supply can change the values.

6.4 Changing water softening setting

1. Open the appliance door.
2. Press On / Off button.
3. Press and hold Programme button immediately for 6 seconds.

The display shows the current water softener level.

4. Press Programme button to select the water softening level.

The level is set after 6 seconds.

6.5 Filling the detergent dispenser

- !** **CAUTION!**
Use only detergents for dishwashers.

1. Press the release button to open the lid of the detergent dispenser.

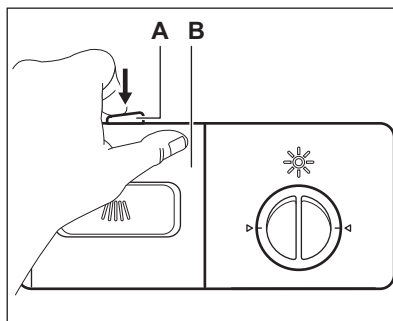

2. Put the detergent (approximately 15 g) in the compartment (C). Put detergent tablets in part (E) of the compartment.

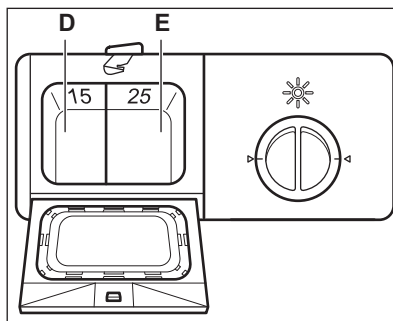
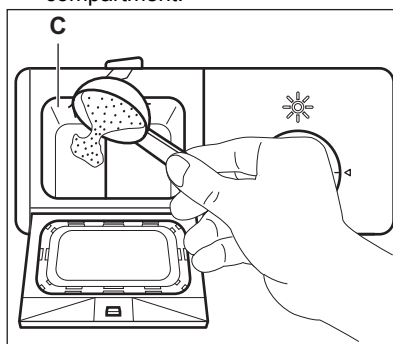

- a. If the programme has a prewash phase, put a small quantity of detergent (approximately 3 g) on the lid of the detergent dispenser.
3. Close the detergent dispenser. Press the lid until the release button locks into position.

- i** Refill the detergent dispenser before each wash cycle.

6.6 Using detergent, salt and rinse aid separately

1. Fill the salt container and the rinse aid dispenser.
2. Start a programme without loading dishes.
3. When the programme is completed, adjust the position of the rinse aid dispenser.

6.7 Using the rinse aid dispenser



CAUTION!

Use only rinse aid designed for dishwashers.

Rinse aid helps to dry the dishes without streaks and stains. The rinse aid is automatically released during the last rinsing phase.

1. Turn the rinse aid dispenser cap counterclockwise and remove it.

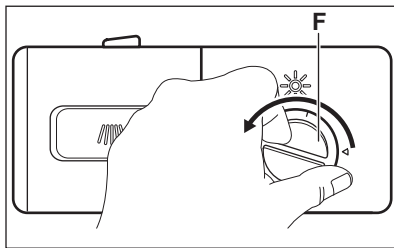

2. Fill the rinse aid dispenser with rinse aid.

The mark "MAX" shows the maximum level.

3. Remove the spilled rinse aid with an absorbent cloth to prevent too much foam during the programme.
4. Put the cap on again and turn it clockwise until it locks.

Make sure that the signs on the cap and on the dispenser are aligned.

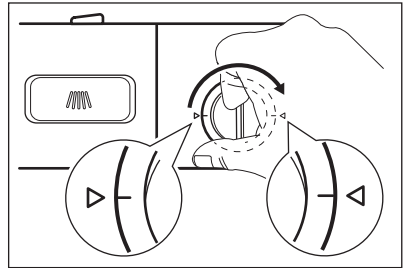

5. Turn the rinse aid selector (A) to adjust the dosage.

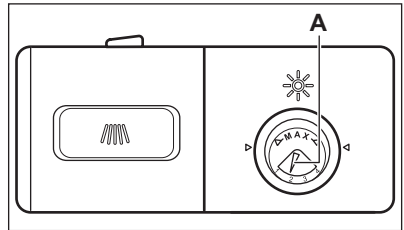

7. HINTS AND TIPS

7.1 General

Follow the hints below to ensure optimal cleaning and drying results in daily use and to protect the environment.

- Washing dishes in the dishwasher as instructed in the user manual usually consumes less water and energy than washing dishes by hand.
- Load the dishwasher to its full capacity to save water and energy. For best cleaning results, arrange items in the baskets as instructed in the user manual and do not overload the baskets.
- Do not pre-rinse dishes by hand. It increases the water and energy

consumption. When needed, select a programme with a prewash phase.

- Remove larger residues of food from the dishes and empty cups and glasses before putting them inside the appliance.
- Soak or slightly scour cookware with firmly cooked-on or baked-on food before washing it in the appliance.
- Make sure that items in the baskets do not touch or cover each other. Only then can the water completely reach and wash the dishes.
- You can use dishwasher detergent, rinse aid and salt separately or you can use the multi-tablets (e.g. "All in 1"). Follow the instructions on the packaging.

- Select a programme according to the type of load and the degree of soil. ECO offers the most efficient use of water and energy consumption.
- To prevent limescale buildup inside the appliance:
 - Refill the salt container whenever necessary.
 - Use the recommended dosage of the detergent and rinse aid.
 - Make sure that the current level of the water softener agrees with the hardness of the water supply.
 - Follow the instructions in the chapter "**Care and cleaning**".

7.2 Using salt, rinse aid and detergent

- Only use salt, rinse aid and detergent designed for dishwasher. Other products can cause damage to the appliance.
- In areas with hard and very hard water, we recommend to use basic dishwasher detergent (powder, gel, tablets containing no additional agents), rinse aid and salt separately for optimal cleaning and drying results.
- Detergent tablets do not fully dissolve with short programmes. To prevent detergent residues on the tableware, we recommend that you use tablets with long programmes.
- Always use the correct quantity of detergent. Insufficient dosage of detergent can result in poor cleaning results and hard-water filming or spotting on the items. Using too much detergent with soft or softened water results in detergent residues on the dishes. Adjust the amount of detergent based on the water hardness. Refer to the instructions on the detergent packaging.
- Always use the correct quantity of rinse aid. Insufficient dosage of rinse aid decreases the drying results. Using too much rinse aid results in bluish layers on the items.
- Make sure that the water softener level is correct. If the level is too high, the increased quantity of salt in the water might result in rust on cutlery.

7.3 Using the baskets

- Always use the whole space of the baskets.
- Use the appliance to wash dishwasher-safe items only.
- Do not wash in the appliance items made of wood, horn, aluminium, pewter and copper as they could crack, warp, get discoloured or pitted.
- Do not wash in the appliance items that can absorb water (sponges, household cloths).
- Put hollow items (cups, glasses and pans) with the opening facing downwards.

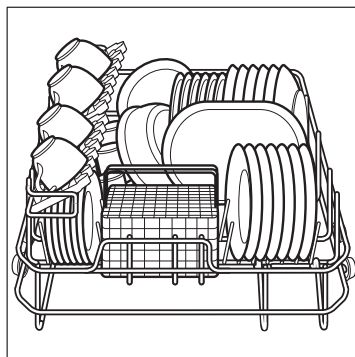

- Make sure that glass items do not touch each other.
- Mix spoons with other cutlery to prevent them from bonding together.
- The cutlery basket has 2 cutlery grids that can be easily removed.

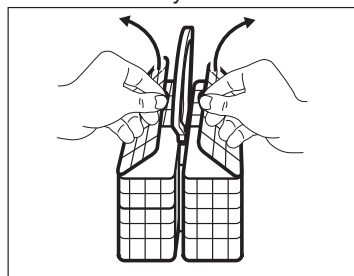

- Make sure that the spray arms can move freely before you start a programme.
- Let the tableware cool down before you remove it from the basket. Hot items can be easily damaged.

8. CARE AND CLEANING

8.1 Maintenance



WARNING!

Before maintenance, deactivate the appliance and disconnect the mains plug from the mains socket.



CAUTION!

Do not use the appliance without filters. Make sure that the filters are correctly positioned. An incorrect positioning of the filters will cause bad washing results and damage to the appliance.



Dirty filters and a clogged spray arm decrease the washing results. Regularly check and if necessary, clean the filters.

8.2 Removing and cleaning the filters

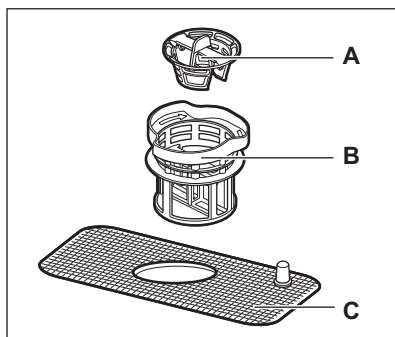

1. Turn the fine filter (B) counterclockwise and remove the filter assembly.
2. Remove the coarse filter (A) by pulling it out from the fine filter (B).
3. Wash the filters with water and a brush.
4. Put the coarse filter (A) into the fine filter (B).
5. Put the filter assembly into the tub and turn the fine filter (B) clockwise until it locks.

8.3 Cleaning the spray arm

Do not remove the spray arm. If the openings in the spray arm are clogged, remove remaining parts of soil with a thin pointed object.

8.4 External cleaning

- Clean the appliance with a moist soft cloth.
- Only use neutral detergents.
- Do not use abrasive products, abrasive cleaning pads or solvents.

8.5 Internal cleaning

- Carefully clean the appliance, including the rubber gasket of the door, with a soft damp cloth.
- To maintain the performance of your appliance, use a cleaning product designed specifically for dishwashers at least once a month. Carefully follow the instructions on the packaging of the product.
- Do not use abrasive products, abrasive cleaning pads, sharp tools, strong chemicals, scourer or solvents.
- Using short-duration programmes regularly can cause grease and limescale buildup inside the appliance. Run long-duration programmes at least twice a month to prevent the buildup.

8.6 Removal of foreign objects

Check the filters and the sump after each use of the dishwasher. Foreign objects (e.g. pieces of glass, plastic, bones or toothpicks, etc) decrease the cleaning performance and can cause damage to the drain pump.



CAUTION!

If unable to remove the foreign objects, contact an Authorised Service Centre.

1. Disassemble the filters system as instructed in this chapter.
2. Remove any foreign objects manually.

3. Reassemble the filters as instructed in this chapter.

9. TROUBLESHOOTING



WARNING!

Refer to Safety chapters.

9.1 What to do if...

With some problems programme indicators flash intermittently indicating a malfunction.

Problem	Possible solution
You cannot activate the appliance.	<ul style="list-style-type: none"> • Make sure that the mains plug is connected to the mains socket. • Make sure that there is no damaged fuse in the fuse box.
The programme does not start.	<ul style="list-style-type: none"> • Make sure that the appliance door is closed. • Press the start button. • If the delay start is set, cancel the setting or wait for the end of the countdown.
The appliance does not drain the water.	<ul style="list-style-type: none"> • Make sure that the drain hose is correctly connected. • Make sure that the filters in the appliance are clean. • Make sure that the kitchen sink drains correctly.
The appliance does not fill with water and an intermittent acoustic signal sounds for approximately 30 seconds. The display shows E1.	<ul style="list-style-type: none"> • Make sure that the water tap is open. • Make sure that the pressure of the water supply is not too low. For this information, contact your local water authority. • Make sure that the water tap is not clogged.
The required temperature is not reached. The display shows E3.	<ul style="list-style-type: none"> • Contact an Authorised Service Centre.
The anti-flood device is on and an intermittent acoustic signal sounds for approximately 30 seconds. The display shows E4.	<ul style="list-style-type: none"> • Close the water tap and contact an Authorised Service Centre.
Technical malfunction of the appliance. The display shows Ed.	<ul style="list-style-type: none"> • Contact an Authorised Service Centre.

Once you have checked the appliance, set and start the programme again. If the problem occurs again, contact an Authorised Service Centre.

For alarm codes not described in the table, contact an Authorised Service Centre.

9.2 The dishwashing and drying results are not satisfactory

Problem	Possible cause	Possible solution
The dishes are not clean.	The selected programme was not applicable for the type of load and / or for the degree of soil.	Make sure that the programme is suitable to the type of load and / or for the degree of soil.
	The basket was not loaded correctly, water did not reach all surfaces.	Load the basket correctly.
	The spray arm could not turn freely because of the incorrect arrangement of the load.	Make sure that the spray arm can turn freely before you start a programme.
	The filters are clogged.	Make sure that the filters are clean.
	The filters are not correctly assembled and installed.	Make sure that the filters are correctly assembled and installed.
	The quantity of detergent was not enough or no detergent was used.	Make sure that a correct amount of detergent is used.
Scale particles on the dishes.	The salt container is empty.	Fill the salt container with specific salt for dishwashers.
	The cap of the salt container is not closed correctly.	Make sure that the salt container is correctly closed.
There are streaks or milky stains on glasses and dishes.	The level of the water softener is too high.	Set the water softener to a lower level.
There are bluish layers on glasses and dishes.	The rinse aid dosage is too high.	Set the rinse aid dispenser to a lower position.
	The detergent can be the cause.	Try a different brand of detergent.
The dishes are wet and dull.	A programme without a drying phase has been selected.	Set a programme with a drying phase.
	The rinse aid dispenser is empty.	Fill the rinse aid dispenser with rinse aid.

10. TECHNICAL DATA

10.1 Technical information

Height (mm)	452
Width (mm)	550
Depth (mm)	518
Depth with the door fully open (mm):	812
Voltage connected load:	see rating plate
Water pressure (MPa):	0.04 - 1.0
Power supply:	see rating plate
Place settings:	6

web link to the registration of this appliance in the EU EPREL database. Keep the energy label for reference together with the user manual and all other documents provided with this appliance.

It is possible to find information related to the performance of the product in the EU EPREL database using the link <https://eprel.ec.europa.eu> and the model name and product number that you can find on the rating plate of the appliance. Refer to the chapter "Product description".

For more detailed information about the energy label, visit www.theenergylabel.eu.

10.2 Link to the EU EPREL database

The QR code on the energy label supplied with the appliance provides a

11. ENVIRONMENTAL CONCERNS

Recycle materials with the symbol . Put the packaging in relevant containers to recycle it. Help protect the environment and human health by recycling waste of electrical and electronic appliances. Do not dispose of

appliances marked with the symbol  with the household waste. Return the product to your local recycling facility or contact your municipal office.

www.electrolux.com/shop



M10001040-A-242022

