



CINEMA SB400

powered soundbar speaker



QUICK-START GUIDE

THANK YOU FOR CHOOSING THIS JBL® PRODUCT

The JBL Cinema SB400 powered soundbar speaker system is a complete, integrated sound system that will create an extraordinarily realistic cinema experience in your own living room. The powered soundbar unit can mount on a wall or sit on a shelf and includes all of the cables you need to connect it to your TV and your cable/satellite tuner or disc player. The wireless subwoofer unit supplies all of your entertainment's drama and impact, and can be placed anywhere without needing to be connected to the soundbar unit.

We're confident that this JBL system will provide every note of enjoyment that you expect – and that when you think about purchasing additional audio equipment for your home, car or office, you will once again choose JBL products.

This quick-start guide contains all the information you need to set up, connect and adjust your new speaker system. For more in-depth information, go to our Web site: www.jbl.com.

INCLUDED ITEMS

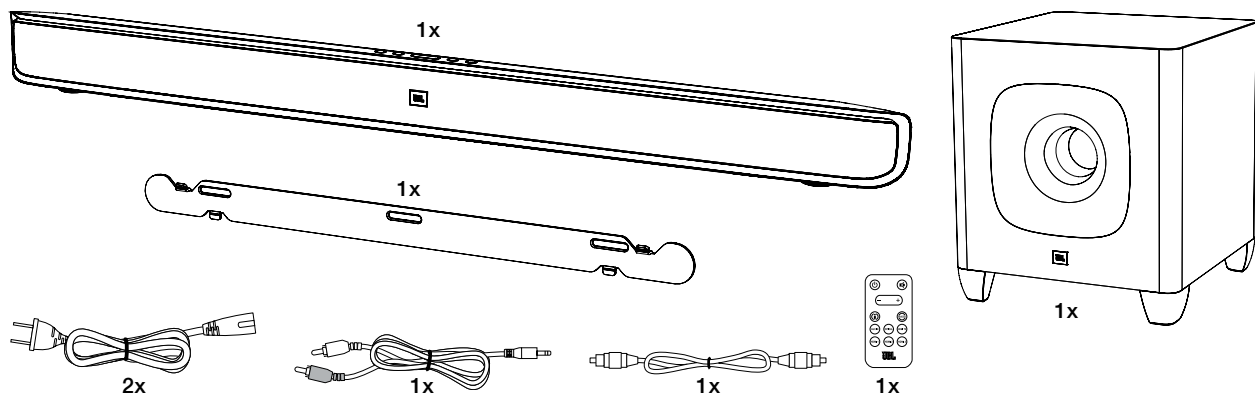

SOUNDBAR REAR-PANEL CONTROLS AND CONNECTIONS

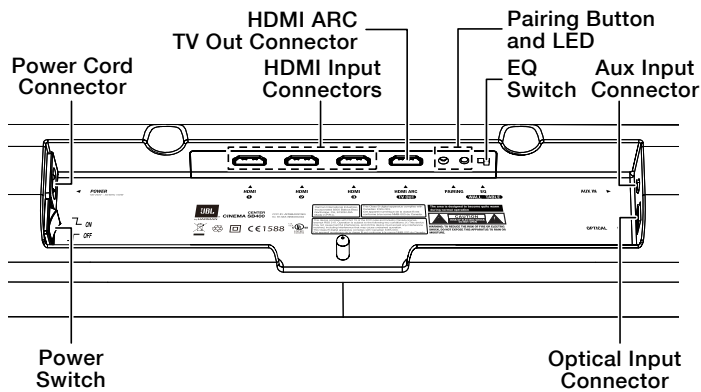

Power switch: Set this switch to the “On” position to activate the soundbar. In normal operation, this switch will be left in the “On” position. See *Turning the Soundbar On and Off*, on page 5, for more information.

Power Cord connector: Connect the included power cord here. See *Power Connections*, on page 5, for more information.

HDMI® Input connectors: HDMI connections transmit digital audio and video signals between devices. If you have source devices with HDMI connectors, using them will provide the best possible audio and video performance quality.

HDMI ARC TV Out connector: If your TV has an HDMI input, use an HDMI cable (not supplied) to connect it to the soundbar’s HDMI ARC TV Out connector. The soundbar will pass video from source devices connected to its HDMI Input connectors, along with its own on-screen information display to the TV. If your TV is equipped with the HDMI Audio Return Channel (ARC) Function, you can feed its sound to the soundbar via the HDMI ARC TV Out connection, and it will not require additional audio connections to the soundbar. The ARC signal is active when the HDMI TV source is selected.

Pairing button and LED: Press the Pairing button to initiate wireless pairing between the soundbar and the wireless subwoofer. See *Pairing the Units for Wireless Operation*, on page 6, for more information.

EQ switch: Use this switch to adjust the soundbar’s bass for either wall or table mounting. If you’re mounting the soundbar on a wall with the included wall-mount bracket, set the EQ switch to the “Wall” position for the most natural-sounding bass performance. If you are placing the soundbar on a table, set the EQ switch to the “Table” position for the most natural-sounding bass performance.

Aux input connection: Use the included stereo 3.5mm to stereo RCA audio cable to connect the stereo analog outputs of your TV, disc player or cable/satellite tuner here.

Optical Input connector: If your TV, disc player or cable/satellite tuner has an optical digital output, use the included optical cable to connect it here.

IMPORTANT: Do not connect the power cord to an AC outlet until you have made and verified all other connections.

If you will not be using the soundbar for an extended period – for instance, if you’re going on vacation – set the Power switch to the “0” (off) position.

SOUNDBAR TOP-PANEL CONTROLS AND REMOTE CONTROL

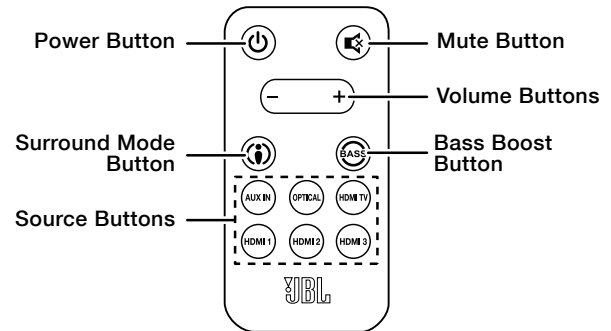
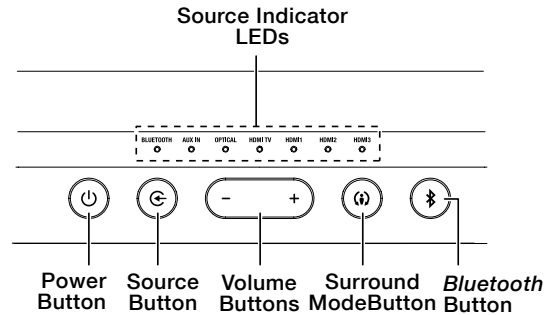

Power button: To turn the system on when the soundbar is in the Standby mode, press the Power button on either the soundbar or the remote. (The Power indicator will turn white.) To put the system in the Standby mode, press either Power button while the system is on. (The Power indicator will turn amber.) The subwoofer will remain on for approximately ten minutes after the soundbar goes into the Standby mode. If you do not press the Power button, the soundbar and the subwoofer will both automatically go into the Standby mode approximately 10 minutes after the audio signal ceases.

NOTE: If you put the soundbar into the Standby mode by pressing the Power button, you must manually turn it on by pressing the Power button again. If the soundbar automatically goes into the Standby mode 10 minutes after the audio signal ceases, it will automatically turn on whenever the soundbar detects an audio signal at either input connection.

Mute button (remote control only): Press the Mute button to mute the system. (The Volume +/- indicators both illuminate white.) While the system is muted, press the Mute button again or either Volume button to restore the sound.

NOTE: Pressing both of the soundbar’s Volume buttons at the same time while the system is on will mute the system. Pressing either Volume button while the system is muted will restore the sound.

Surround Mode button: This button turns the soundbar’s HARMAN Display Surround processing on and off. The Surround button indicator turns amber when HARMAN Display Surround is active, and turns white when HARMAN Display Surround is not active (normal stereo sound). See *Changing the Surround Mode*, on page 7, for more information.

Volume buttons: Press the “+” button to increase the volume; press the “-” button to decrease the volume. The buttons illuminate white for a few seconds after being pressed.

Source button: This button cycles between the sources in the following order: *Bluetooth*, *Aux*, *Optical*, *HDMI TV*, *HDMI 1*, *HDMI 2*, *HDMI 3*, *Bluetooth*, etc. The active source’s Source Indicator LED will illuminate.

Note: The remote has an individual selector button for each source except *Bluetooth*.

Bluetooth button (soundbar only): Press this button to play the audio stream from a paired *Bluetooth* device through the soundbar. (The *Bluetooth* Source Indicator LED will illuminate when a paired *Bluetooth* device is the active source.) Press and hold this button to force the soundbar into the *Bluetooth* pairing mode. See *Bluetooth Operation*, on page 7, for more information.

Bass Boost button (remote control only): Press the remote's Bass Boost button to enhance low-frequency performance. Pressing the Bass Boost button again will return the soundbar's normal low-frequency performance.

SUBWOOFER CONTROLS AND CONNECTIONS

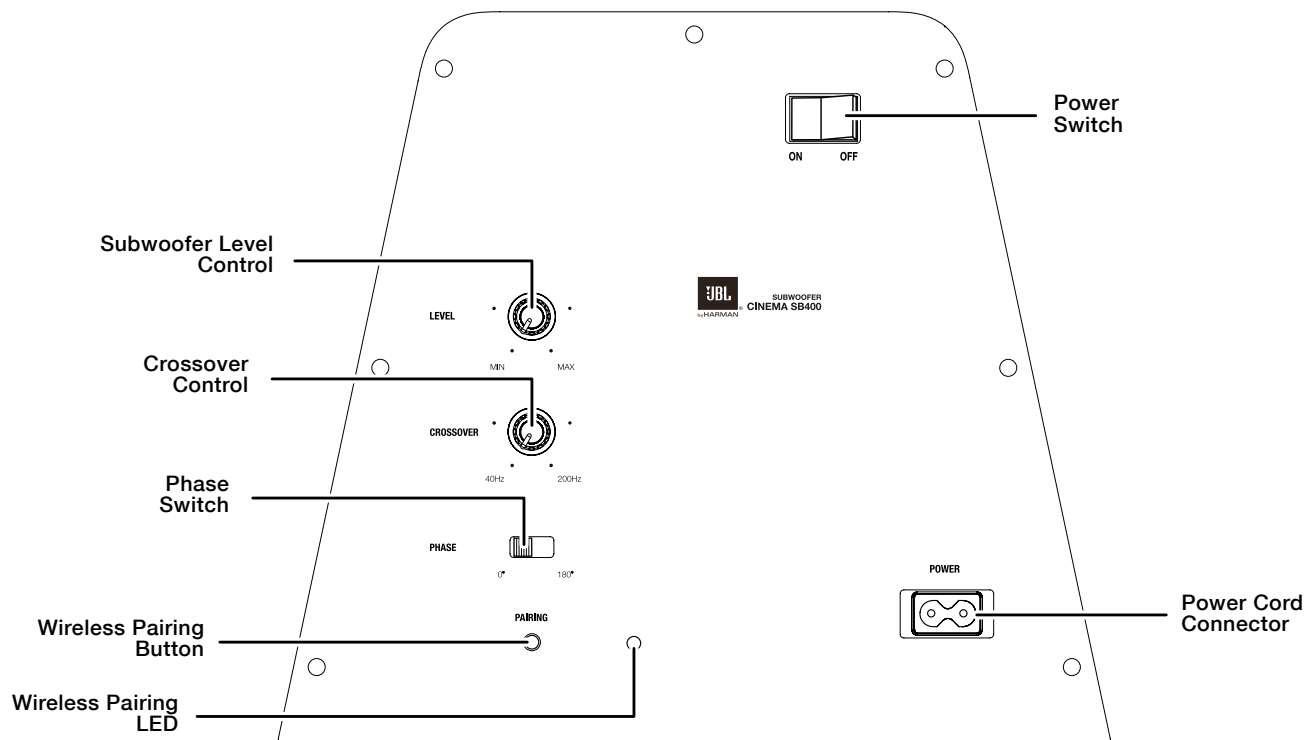

Subwoofer Level control: Use this control to balance the subwoofer's volume with that of the soundbar. Turn the knob clockwise to increase the subwoofer's volume; turn it counterclockwise to decrease the subwoofer's volume.

Crossover control: This knob adjusts the subwoofer's cutoff between 40Hz and 200Hz. The higher you set the Cutoff control, the higher in frequency the subwoofer will operate and the more its bass will "overlap" that of the soundbar. This adjustment helps achieve a smooth transition of bass frequencies between the subwoofer and the soundbar for a variety of different rooms and subwoofer locations. See *Subwoofer Crossover control*, on page 8, for more information.

Phase switch: This switch determines whether the subwoofer driver's piston-like action moves in and out in phase with the speakers in the soundbar. If the subwoofer were to play out of phase with the soundbar speakers, some of the sound waves produced by the subwoofer or soundbar could be canceled, reducing bass performance and sonic impact. This phenomenon depends in part on the relative placement of the speakers in the room. See *Subwoofer Phase switch*, on page 8, for more information.

Wireless Pairing switch and LED: Press this switch to initiate wireless pairing between the subwoofer and the soundbar. See *Pairing the Units for Wireless Operation*, on page 6, for more information.

- The LED lights blue continuously when the subwoofer is on and linked to the soundbar.
- The LED slowly flashes blue when the subwoofer is on and the wireless link is not established between the subwoofer and the soundbar.
- The LED rapidly flashes blue during the wireless pairing process.

Power switch: Set this switch to the "On" position to activate the subwoofer. In normal operation, this switch will be left in the "On" position. See *Turning the Subwoofer On and Off*, on page 6, for more information.

If you will not be using the subwoofer for an extended period – for instance, if you're going on vacation – set the Power switch to the "Off" position.

Power Cord connector: Connect the included power cord here and into an active, unswitched AC outlet. See *Power Connections*, on page 5, for more information.

IMPORTANT: Do not connect the power cord to an AC outlet until you have made and verified all other connections.

SOUNDBAR PLACEMENT

PLACING THE SOUNDBAR ON A TABLE

If your TV is placed on a table, you can place the soundbar on the table directly in front of the TV stand, centered with the TV screen. As long as the surface of the table is flat, the soundbar will rest on its metal feet.

- Set the soundbar's EQ switch in the "Table" position. See *Soundbar Rear-Panel Controls and Connections*, on page 2.

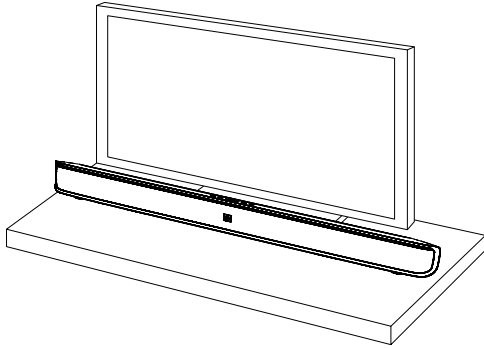

WALL-MOUNTING THE SOUNDBAR

If your TV is attached to a wall, you can use the included wall-mount bracket to mount the soundbar on the wall directly below the TV screen.

1. Determine the location for the soundbar on the wall. Make sure that the top of the soundbar will not block your view of the TV screen when it is mounted on the wall.
2. Hold the bracket against the wall as a template and mark the locations of the soundbar wall-mount bracket holes on the wall. The three holes should be evenly spaced 7-1/16" (18cm) apart, and the bracket slots are designed to accept 4mm screws. Make sure that the holes are at the same height. See the illustration below.

Mark Three Bracket Hole Locations
7-1/16" (18cm) Apart

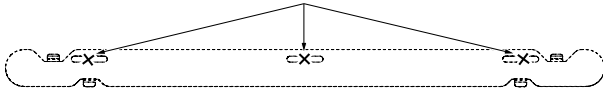

3. Making sure that the bracket's flat side is against the wall, attach the wall-mount bracket to the wall at the locations you marked, using hardware that is appropriate for the wall's construction and materials. Note that the soundbar weighs 7.3 lb (3.3kg). Be sure to use hardware that can support this weight.

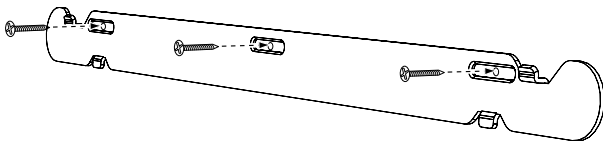

4. After reading the *Connections* section on page 5, connect all cables to the soundbar.

IMPORTANT: Do NOT plug the soundbar's power cord into an AC outlet at this time.

- Set the soundbar's EQ switch in the "Wall" position, and set the soundbar's Power switch in the "On" position. See *Soundbar Rear-Panel Controls and Connections*, on page 2.
5. Attach the soundbar to the bracket by sliding the bracket's upper tabs into the slots on the back of the soundbar. The soundbar's slots allow you to adjust the soundbar's angle on the wall to ensure that it is level.

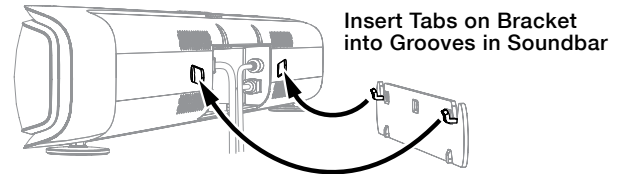

SUBWOOFER PLACEMENT

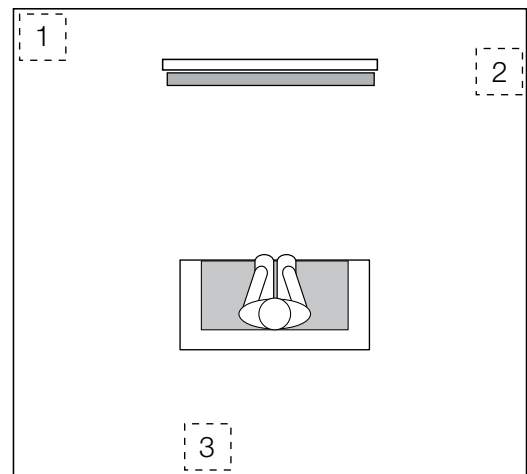

The performance of a subwoofer is directly related to its placement in the listening room and its physical position relative to the other speakers in the system. While it is true that in general our ears do not hear directional sounds at the low frequencies where subwoofers operate, when installing a subwoofer within the limited confines of a room, the reflections, standing waves and absorptions generated within the room will strongly influence the performance of any subwoofer system. As a result, the specific location of the subwoofer in the room does become important to the amount and quality of bass that is produced.

For example, placing the subwoofer next to a wall generally will increase the amount of bass in the room; placing it in a corner (1) generally will maximize amount of bass in the room. However, corner placement can also increase the destructive effect of standing waves on bass performance. This effect can vary depending on the listening position – some listening positions may yield very good results while others may have far too much (or too little) bass at certain frequencies.

In many rooms, placing the subwoofer along the same plane as the soundbar (2) can produce the best integration between the sound of the subwoofer and that of the soundbar. In some rooms, the best performance could even result from placing the subwoofer behind the listening position (3).

We strongly recommend that you experiment with placement before choosing a final location for your subwoofer. One way you can determine the best location for the subwoofer is by temporarily placing it in the listening position and playing music with strong bass content. Move around to various locations in the room while the system is playing (putting your ears where the subwoofer would be placed), and listen until you find the location where the bass performance is best. Place the subwoofer in that location.

CONNECTIONS

SOUNDBAR AUDIO/VIDEO CONNECTIONS

HDMI ARC TV Out: If your TV has an HDMI input, use an HDMI cable (not supplied) to connect it to the soundbar's HDMI ARC TV Out connection. The soundbar will pass video from source devices connected to its HDMI Input connectors, along with its own on-screen display information, to the TV. If your TV is equipped with the HDMI Audio Return Channel (ARC) Function, you can feed its sound to the soundbar via the HDMI ARC TV Out connection, and it will not require additional audio connections to the soundbar. The ARC signal is active when the HDMI TV source is selected.

NOTE: The soundbar's on-screen information display (OSD) only appears through the HDMI ARC TV Out connector. If you want to see the soundbar's OSD you need to connect its HDMI ARC TV Out connector to your TV even if you are not connecting any HDMI video source devices to the soundbar's HDMI In 1/2/3 connectors (below). See *On-Screen Information Display*, on page 6, for more information.

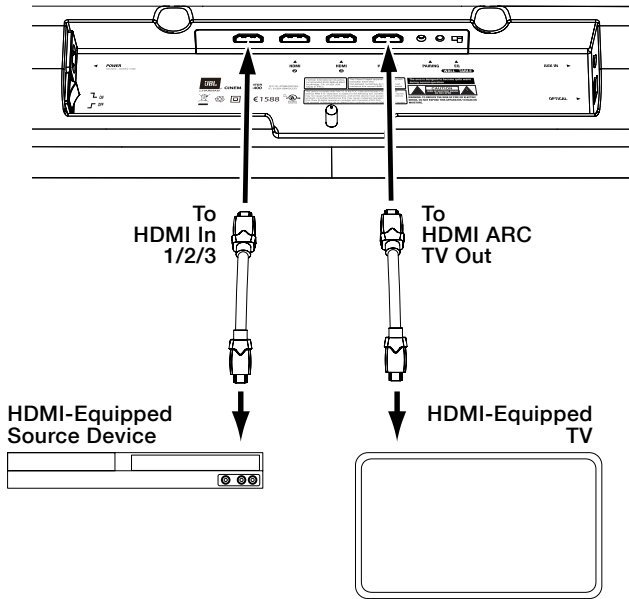

HDMI In 1/2/3: If any of your source devices have HDMI connectors, connect them to the soundbar's HDMI In 1/2/3 connectors for the best possible video and audio performance quality. Since the HDMI cable carries both digital video and digital audio signals, you do not have to make any additional audio connections for source devices you connect via HDMI connectors.

Aux In and Optical In connections: If your TV and source devices do not have HDMI connections, you can use the supplied audio cable and optical cable to connect your TV and one source device to the soundbar's Aux In and Optical In connectors, respectively.

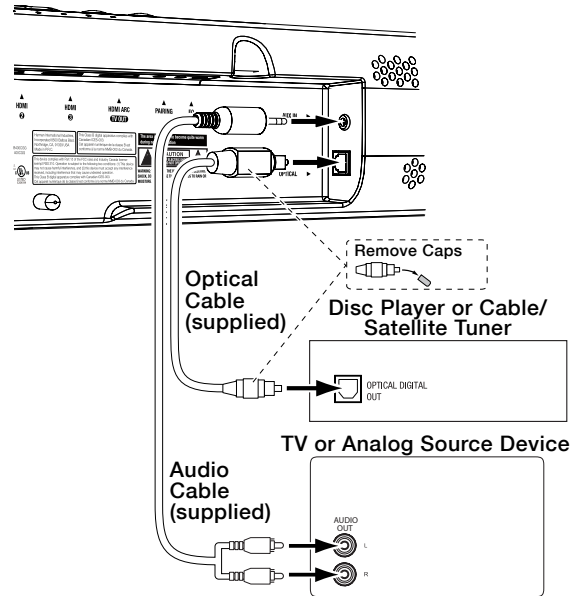

NOTE: If your source devices have HDMI connectors, using them will provide superior audio quality.

POWER CONNECTIONS

After verifying that all of the source connections have been made properly, plug the supplied power cords into the soundbar's and subwoofer's Power Cord connectors, and plug the other ends into active, *unswitched* AC outlets. Do NOT plug these cords into the accessory outlet found on some audio components.

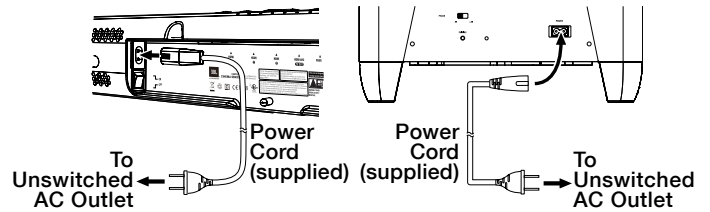

USING YOUR SOUNDBAR SYSTEM

TURNING THE SOUNDBAR ON AND OFF

Set the soundbar's Power switch to the "On" position. Press the Power button on either the soundbar or the remote to turn the soundbar on. To put the soundbar in the Standby mode, press either Power button while the soundbar is on.

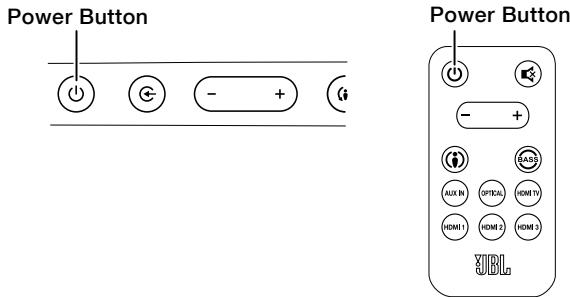

If you do not press the Power button, the soundbar will automatically go into the Standby mode approximately 10 minutes after the audio signal ceases. NOTE: If you have put the soundbar into the Standby mode by pressing the Power button, you must manually turn it on by pressing the Power button again. If the soundbar has automatically gone into the Standby mode 10 minutes after the audio signal has ceased, it will automatically turn itself on when it receives an audio signal at either input connection.

If you will be away from home for an extended period of time, or if you will not be using the soundbar for an extended period, set the soundbar's Power switch to the "Off" position.

TURNING THE SUBWOOFER ON AND OFF

Set the subwoofer's Power switch to the "On" position. Once the subwoofer and soundbar have been paired (see *Pairing the Units for Wireless Operation*, below) the subwoofer will turn on when the soundbar turns on and will remain on for approximately one minute after the soundbar enters the Standby mode, or for approximately 15 minutes after the audio signal ceases.

If you will be away from home for an extended period of time, or if you will not be using the system for an extended period, set the subwoofer's Power switch to the "Off" position.

PAIRING THE UNITS FOR WIRELESS OPERATION

After turning the soundbar and subwoofer on for the first time, you will need to "pair" the subwoofer and soundbar so they both operate at the same wireless frequency. To pair the units, press the Wireless Pairing switches on both units within 30 seconds of each other. The units will communicate with each other and operate at the same frequency.

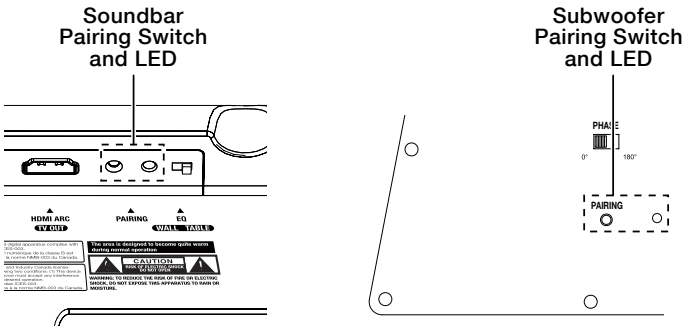

NOTE: The maximum wireless operating distance between the soundbar and subwoofer is approximately 50 feet (15.3m).

ON-SCREEN INFORMATION DISPLAY

The soundbar's on-screen information display (OSD) will appear on the screen of a TV connected to the HDMI ARC TV Out connector to verify operating status. The OSD will overlay on top of the TV's video program for five seconds after you press a button on the soundbar or remote, then will disappear. (When you select an audio-only source connection (Aux, Optical, *Bluetooth*), the OSD information will overlay a JBL splash screen.)

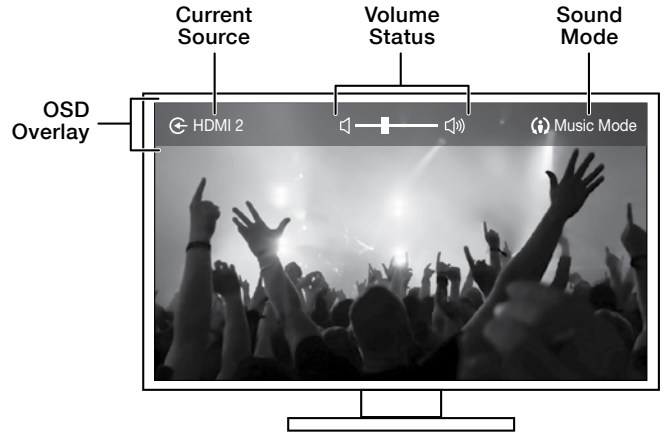

- Mute: When the audio signal is muted, the OSD will display the following icon:



- **Bluetooth:** The OSD will display the following icons during *Bluetooth* operation:



Bluetooth Pairing



Bluetooth Connected



Bluetooth Streaming



Bluetooth Not Connected

In addition to the status information, the OSD will also display messages if the selected HDMI connection can't be detected or if the video signal is lost.

BLUETOOTH OPERATION

To wirelessly stream audio to the soundbar from a *Bluetooth*-enabled device:

1. Confirm that the soundbar is in the *Bluetooth* pairing mode (the *Bluetooth* button LED will be flashing blue). If the LED is not flashing blue, press and hold the *Bluetooth* button until its LED begins to flash blue.

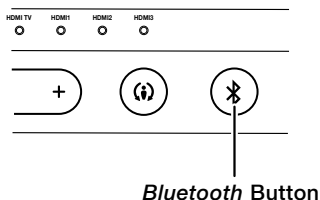

2. Place the device in the pairing mode. Use the device's *Bluetooth* pairing menu to pair it with the soundbar. (The soundbar will appear as "SB400" in the device's menu.) If the device requires a passcode, use 0000.
3. When the soundbar's *Bluetooth* button LED illuminates constantly, it is paired with the device and you can stream audio via *Bluetooth* from the device to the soundbar.

To listen to audio from the *Bluetooth* device, press the Source button repeatedly until the *Bluetooth* Source Indicator LED illuminates (see *Switching Sources*, below).

To disconnect the *Bluetooth* device, press and hold the soundbar's *Bluetooth* button until the LED begins flashing. To pair the soundbar with a different *Bluetooth*-enabled device, repeat Steps 1 – 3 with the new device.

Notes on *Bluetooth* operation:

- You can manually switch sources to the paired *Bluetooth* device by pressing the soundbar's *Bluetooth* button.
- If you switch the soundbar to a different source while a paired *Bluetooth* device is streaming to the soundbar, the soundbar will send a Stop command and the *Bluetooth* device will stop streaming.

SWITCHING SOURCES

Press the soundbar's Source button to cycle between the sources in the following order: *Bluetooth*, Aux, Optical, HDMI TV, HDMI 1, HDMI 2, HDMI 3, *Bluetooth*, etc. (The remote has an individual selector button for each source except *Bluetooth*.) The active source's Source Indicator LED will illuminate.

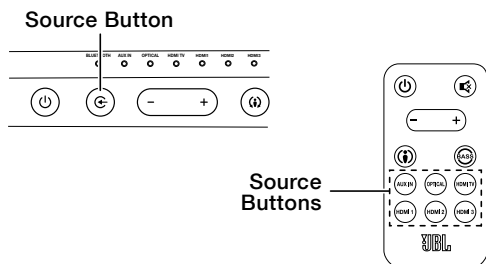

ADJUSTING THE SYSTEM'S VOLUME

Press the soundbar's or remote's Volume + and – buttons to raise and lower the system's volume one step at a time. Hold down the buttons to continuously raise or lower the volume.

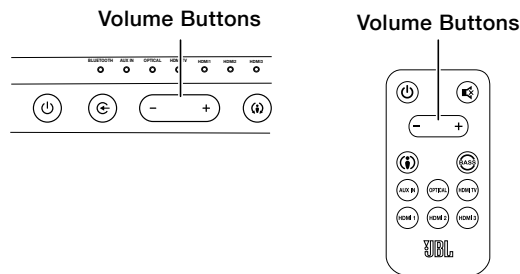

For the best sound, we recommend turning your TV's built-in speakers off. Consult your TV's owner's manual to find out how to do this.

MUTING THE SYSTEM

Momentarily press both of the soundbar's Volume buttons at the same time, or press the remote's Mute button to mute the system. (Both Volume indicators illuminate and the OSD displays the Mute icon.) Momentarily press either of the soundbar's Volume buttons or press the remote's Mute button again to un-mute the system. (The Volume indicators turn off.)

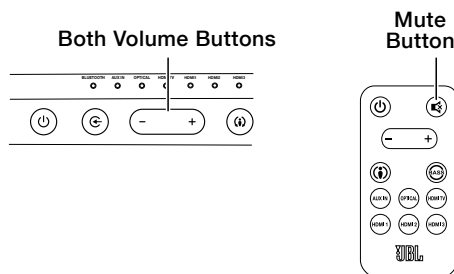

CHANGING THE SURROUND MODE

Press the soundbar's or remote's Surround Mode indicator to switch the sound between normal stereo (the Surround Mode indicator lights white and the OSD displays "Music" as the sound mode) and HARMAN Display Surround (the Surround Mode indicator lights amber and the OSD displays "Movie" as the sound mode). The HARMAN Display Surround setting will produce a complete surround-sound experience for anyone sitting in front of and several feet away from the soundbar. Although it is particularly effective when watching movies, you can also try the HARMAN Display Surround setting for music.

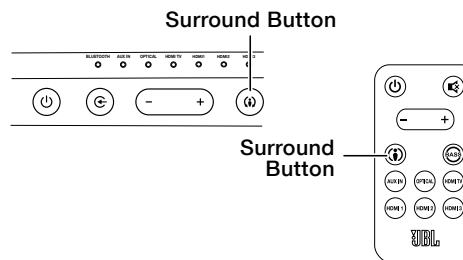

BOOSTING THE BASS

Press the remote's Bass Boost button to enhance low-frequency performance, resulting in bass with more impact, which you may prefer while watching movies or listening to music. The OSD will display "Bass On" as the sound mode. There is no harm in experimenting with this control. Pressing the Bass Boost button again will return the soundbar's normal low-frequency performance.

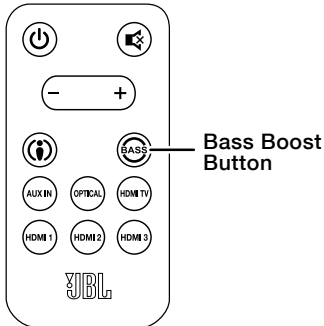

SUBWOOFER LEVEL CONTROL

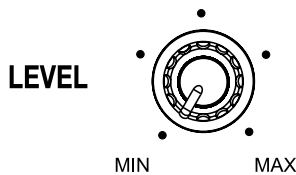

Use the subwoofer's Level knob to balance the bass with the rest of the sound. Play music or movies that you are familiar with, and adjust the subwoofer's Level knob so the bass sounds balanced on both music and films. Listen to several different music recordings and film soundtracks that contain strong bass passages, and find a setting for the Level knob that doesn't over-emphasize the bass or make it sound weak.

Once you find a setting for the subwoofer's Level knob that balances the bass with the rest of the sound, you shouldn't have to change it.

SUBWOOFER CROSSOVER CONTROL

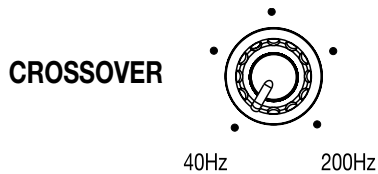

The subwoofer's Crossover control adjusts the subwoofer's cutoff between 40Hz and 200Hz. The higher you set the Crossover control, the higher in frequency the subwoofer will operate and the more its bass will "overlap" that of the soundbar. This adjustment helps achieve a smooth transition of bass frequencies between the subwoofer and the soundbar for a variety of different rooms and subwoofer locations.

To set the Crossover control, listen for the smoothness of the bass. If the bass seems too strong at certain frequencies, try a lower Crossover control setting. If the bass seems too weak at certain frequencies, try a higher Crossover control setting.

SUBWOOFER PHASE SWITCH

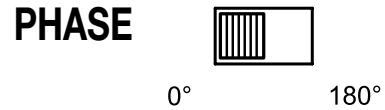

This switch determines whether the subwoofer's piston-like action moves in and out in phase with the speakers in the soundbar. If the subwoofer were to play out of phase with the soundbar speakers, some of the sound waves produced by the soundbar and subwoofer could be canceled out at some frequencies, reducing bass performance and sonic impact. This phenomenon depends in part on the relative placement of the soundbar and subwoofer in the room.

Although there is no absolutely correct setting for the Phase switch, in most cases it should be left in the "0°" position. When the subwoofer is properly in phase with the soundbar speakers, the sound will be clearer and have more impact. It will make percussive sounds like drums, piano and plucked strings sound more lifelike. The best way to set the Phase switch is to listen to music that you are familiar with and adjust the switch so that drums and other percussive sounds have maximum impact.

LEARNING YOUR TV REMOTE'S VOLUME AND MUTE COMMANDS

You can program the soundbar so it will respond to your TV remote's volume up, volume down and mute commands. This will let you control both the soundbar and your TV with a single remote. Before you begin to program the soundbar, have your TV remote in hand.

1. Press and hold the soundbar's Surround button until the button begins flashing amber.

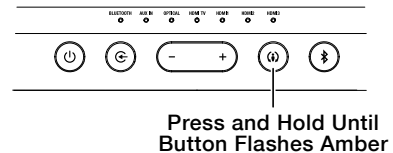

2. Hold your TV's remote approximately 12" (30cm) from the indicated location at the front of the soundbar and aim the remote directly at the soundbar:

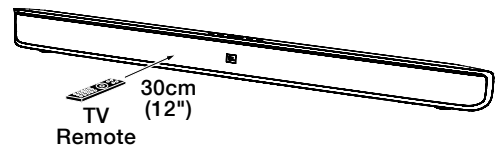

- Press the TV remote's volume up button while pressing and holding the soundbar's Volume + button. If the programming was successful the soundbar's Surround button will change from amber to solid white for one second, then will return to flashing amber.

A) Hold Down Soundbar's Volume + Button

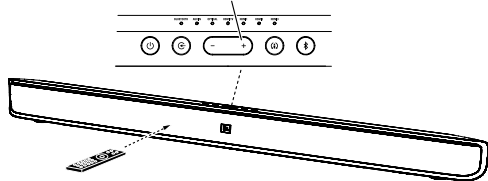

B) Press TV Remote's Volume Up Button

- Press the TV remote's volume down button while pressing and holding the soundbar's Volume – button. If the programming was successful the soundbar's Surround button will change from amber to solid white for one second, then will return to flashing amber.

A) Hold Down Soundbar's Volume – Button

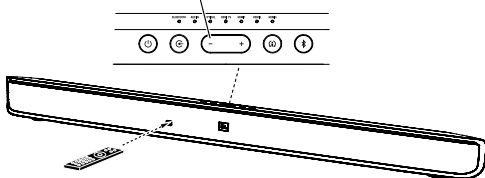

B) Press TV Remote's Volume Down Button

- Press the TV remote's mute button while pressing and holding the soundbar's Volume + and Volume – buttons at the same time. If the programming was successful the soundbar's Surround button will change from amber to solid white for one second, then will return to flashing amber.

A) Hold Down Soundbar's Volume + and – Button

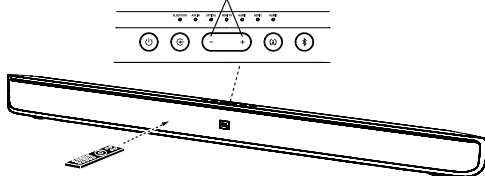

B) Press TV Remote's Mute Button

3. When you're finished, press and hold the soundbar's Surround button until the button stops flashing amber.

The soundbar will now respond to your TV remote's volume and mute commands.

SPECIFICATIONS

CINEMA SB400 SYSTEM

Frequency response: 38Hz – 20kHz (–6dB)

CINEMA SB400 POWERED SOUNDBAR SPEAKER

Midrange transducers: Two 2-1/4" (57mm) cones per channel

High-frequency transducer: One 1" (25mm) dome per channel

Amplifier power: 60 watts peak per channel

Power requirement: 100V – 240V, 50Hz/60Hz, 60W

Power consumption: <0.5W (standby); 60W (maximum)

Dimensions (H x W x D): 3-3/4" x 43-5/16" x 2-1-2"
(95mm x 1100mm x 64mm)

Weight (shipping): 7.3 lb (3.3kg)

CINEMA SB400 POWERED SUBWOOFER

Low-frequency transducer: One 8" down-firing cone

Amplifier power: 100 watts

Enclosure type: Ported

Power requirement: 100V – 240V, 50/60Hz, 100W

Power consumption: <0.5W (standby); 100W (maximum)

Dimensions (H x W x D): 14" x 13" x 12-5/8"
(355mm x 329mm x 320mm)

Weight (shipping): 23.1 lb (10.5kg)



HARMAN HARMAN International Industries, Incorporated
8500 Balboa Boulevard, Northridge, CA 91329 USA

© 2012 HARMAN International Industries, Incorporated. All rights reserved. JBL is a trademark of HARMAN International Industries, Incorporated, registered in the United States and/or other countries.

The *Bluetooth* word mark and logo are registered trademarks and are owned by the Bluetooth SIG, Inc., and any use of such marks by HARMAN International Industries, Incorporated, is under license.

Manufactured under license from Dolby Laboratories. Dolby and the double-D symbol are trademarks of Dolby Laboratories.

All Rights Reserved. Features, specifications and appearance are subject to change without notice.

Part No. 950-0475-001 Rev: A

www.jbl.com