

EN

**DETAILED  
INSTRUCTIONS**  
FOR USE OF  
REFRIGERATOR-  
FREEZER

***Hisense***

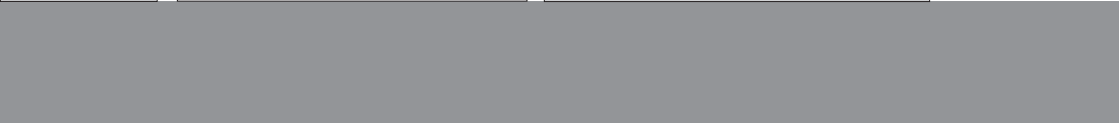
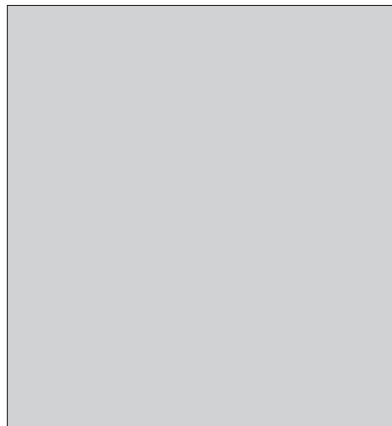
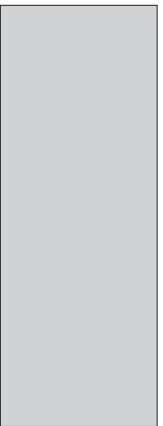
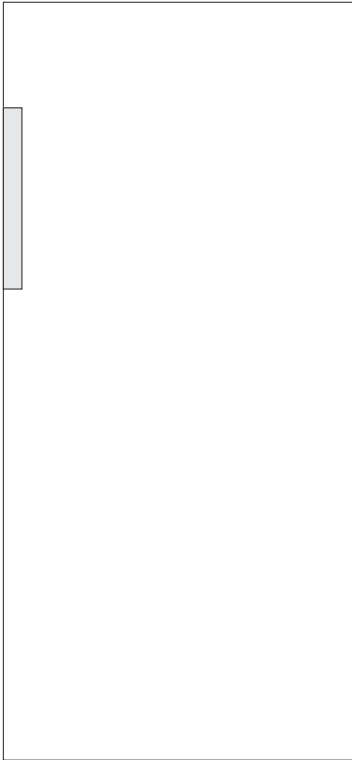

We thank you for the confidence you have shown by purchasing our appliance. We wish you find a lot of pleasure in its use.

**The appliance is intended solely for household use.**

**The refrigerator-freezer** is intended for use in households.

**The lower part is the refrigerator** compartment intended for storing fresh food at temperatures above 0°C.

**The upper part is the freezer** compartment intended for freezing fresh food and long-term storage of frozen food (up to one year, depending on the type of food). This compartment is labeled with four stars / asterisks.

# TABLE OF CONTENTS

<b>4 IMPORTANT NOTES AND PRECAUTIONS</b> ..... <b>10 ADVICE FOR SAVING POWER WITH REFRIGERATION APPLIANCES</b>	<b>INTRODUCTION</b>
<b>11 APPLIANCE DESCRIPTION</b> ..... <b>12 INSTALLATION AND CONNECTION</b> ..... <b>14 CHANGING THE DIRECTION OF DOOR OPENING</b> ..... <b>15 OPERATING THE APPLIANCE</b> ..... <b>17 APPLIANCE INTERIOR EQUIPMENT</b> ..... <b>21 RECOMMENDED DISTRIBUTION OF FOOD IN THE APPLIANCE</b>	<b>APPLIANCE DESCRIPTION</b>
<b>22 STORING FOOD IN THE REFRIGERATOR</b> ..... <b>23 STORING FOOD IN THE FRESHZONE DRAWER</b> ..... <b>24 FREEZING AND STORING FROZEN FOOD</b> 24 Freezing process 24 Important warnings on freezing fresh food 25 Avoid contamination of food 25 Storage of industrially frozen food 25 Frozen food storage time 25 Defrosting frozen food	<b>STORING AND FREEZING FOOD</b>
<b>26 DEFROSTING THE APPLIANCE</b> ..... <b>27 CLEANING THE APPLIANCE</b>	<b>DEFROSTING AND CLEANING THE APPLIANCE</b>
<b>28 TROUBLESHOOTING</b> ..... <b>29 INFORMATION ABOUT APPLIANCE NOISE</b>	<b>OTHER</b>

# IMPORTANT NOTES AND PRECAUTIONS

---

## **i** BEFORE USING THE APPLIANCE FOR THE FIRST TIME

Before connecting the appliance to the power mains, please read carefully the instructions for use which describe the appliance and its correct and safe use. The instructions apply to several appliance types/models; thus, settings or equipment may be described herein which is not available in your appliance. We recommend saving this instruction manual for future reference and attach it to the appliance if it is sold in the future.

Check for any damage or irregularities on your appliance. If you find your appliance is damaged, notify the retailer from which you have purchased the appliance.

Before connecting the appliance to the power mains, let the appliance rest in a vertical position for a minimum of 2 hours. This will reduce the possibility of operation faults due to the effect of transport on the cooling system.

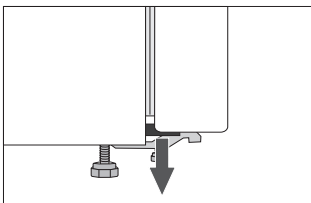

Spacers are fitted on the corners of the doors. Remove them and insert the supplied plugs into their slots (only in some models).



## IMPORTANT SAFETY INSTRUCTIONS



WARNING! Risk of fire/flammable materials.

The appliance must be connected to the power mains and grounded in compliance with the effective standards and regulations.

WARNING! Do not locate multiple portable socket-outlets or portable power supplies at the rear of the appliance.

Before cleaning the appliance, unplug it from the power mains (unplug the power cord from the wall outlet).

WARNING! If the supply cord is damaged, it must be replaced by the manufacturer, its service agent or similarly qualified persons in order to avoid a hazard.

WARNING! When positioning the appliance, ensure the supply cord is not trapped or damaged.

If LED lighting does not work, call a service technician. Do not attempt a repair of the LED lighting yourself, as there is danger of contact with high voltage!



WARNING! Do not use electrical appliances inside the food storage compartments of the appliance, unless they are of the type recommended by the manufacturer.



WARNING! Do not use mechanical devices or other means to accelerate the defrosting process, other than those recommended by the manufacturer.



WARNING! To avoid any hazard resulting from poor stability of the appliance, make sure it is installed as instructed.

## **Danger of frostbite**

Never put frozen food in your mouth and avoid touching frozen food as this may cause frostnip or frostbite.

## **Safety of children and vulnerable persons**

The appliance is not intended for use by persons (including children) with reduced physical, sensory or mental capabilities, or lack of experience and knowledge, unless they have been given supervision or instruction concerning use of the appliance by a person responsible for their safety.

Children should be supervised to ensure that they do not play with the appliance.

Cleaning and user maintenance shall not be made by children without supervision.

Remove the packaging intended to protect the appliance or particular parts during transport and keep it outside the reach of children.

It presents danger of injury or suffocation.

When removing a used appliance, disconnect the power cord, remove the door, and leave the shelves in the appliance. This will prevent children from locking themselves in the appliance.

## **For European markets only**

This appliance can be used by children aged from 8 years and above and persons with reduced physical, sensory or mental capabilities or lack of experience

and knowledge if they have been given supervision or instruction concerning use of the appliance in a safe way and understand the hazards involved.

Children shall not play with the appliance.

Cleaning and user maintenance shall not be made by children without supervision.

Children aged from 3 to 8 years are allowed to load and unload refrigerating appliances.

### **Warning regarding the refrigerant**

The appliance contains a small amount of an environmentally friendly yet flammable gas R600a.

Make sure that no parts of the cooling system are damaged. A gas leak is not hazardous to the environment, but it could cause eye injury or fire.

In case of a gas leak, ventilate the room thoroughly, disconnect the appliance from the power mains, and call a service technician.

# IMPORTANT INFORMATION ON THE USE OF APPLIANCE

WARNING! This appliance is intended to be used in household and similar applications such as:

- staff kitchen areas in shops, offices and other working environments;
- farm houses and by clients in hotels, motels and other residential type environments;
- bed and breakfast type environments;
- catering and similar non-retail applications.

**i** WARNING! Keep ventilation openings, in the appliance enclosure or in the built-in structure, clear of obstruction.

The appliance may not be used outdoors and it may not be exposed to rain.

Do not store explosive substances such as aerosol cans with a flammable propellant in this appliance.

If the appliance will be out of use for an extended period of time, switch it off using the relevant button, and unplug it from the power mains. Empty the appliance, defrost it, clean it, and leave the door ajar.

In case of an error or power supply failure, do not open the freezer compartment unless the freezer has not operated for over 16 hours. After this period, use the frozen food or provide sufficient cooling (e.g. a replacement appliance).



## Technical information on the appliance

Rating plate can be found in the appliance interior. It indicates data on voltage, gross and net volume, type and amount of refrigerant, and information on the climate classes.

If the language on the rating plate is not the language of your choice or the language of your country, replace it with the one supplied.



## ENVIRONMENT PROTECTION

Packaging is made of environmentally friendly materials that can be recycled, disposed of, or destroyed without any hazard to the environment.



### Removing an obsolete appliance

To protect the environment, take the obsolete appliance to an authorized home appliance collection centre.

Before doing so, do the following:

- disconnect the appliance from the power mains;
- do not allow children to play with the appliance.



**WARNING!** Do not damage the refrigerant circuit. This will also prevent pollution.



**The symbol on the product or its packaging indicates that the product should not be treated as normal household waste. The product should be taken to an authorized collection centre for waste electric and electronic equipment processing. Correct disposal of the product will help prevent any negative effects on the environment and health of people which could occur in case of incorrect product removal. For detailed information on removal and processing of the product, please contact the relevant municipal body in charge of waste management, your waste disposal service, or the store where you bought the product.**

# ADVICE FOR SAVING POWER WITH REFRIGERATION APPLIANCES

---

- Install the appliance as specified in the instruction manual.
- Do not open the door more often than necessary.
- Occasionally make sure air circulation underneath the appliance is unobstructed.
- Condenser unit on the rear wall should be kept clean (see chapter Cleaning the appliance).
- If the gasket is damaged or does not provide a perfect seal for other reasons, have it replaced as soon as possible.
- Store the food in tightly sealed containers or appropriate packaging.
- Before placing the food in the appliance, cool it to room temperature.
- Defrost frozen food in the refrigerator compartment.
- Remove some of the drawers from the freezer compartment as described in the instruction manual, in order to make use of the entire interior.
- Defrost your conventional freezer when an approximately 3-5 millimeter layer of frost or ice has built up on the refrigerated surfaces.
- Make sure the layout of shelves in the compartment is uniform and that the food is placed so that the air can freely circulate in the appliance interior (observe the recommended placement of food as described in the instructions).
- In appliances with a fan, do not block the fan slots.
- If you do not need the fan or the ionizer, switch them off to reduce power consumption.

# APPLIANCE DESCRIPTION

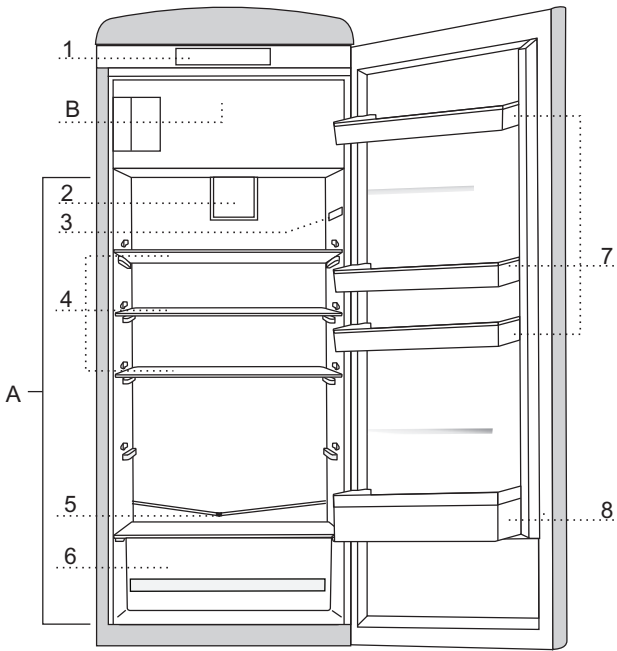

## A Refrigerator compartment B Freezer compartment

- 1 Control unit
- 2 Fan
- 3 LED lighting of refrigerator interior
- 4 Pull-out glass shelf (heightadjustable)
- 5 Water discharge gutter / groove
- 6 CrispZone fruit and vegetables drawer with humidity control
- 7 Height-adjustable door bin
- 8 Bottle shelf

- Appliance interior equipment may change according to the appliance model.
- The drawers are protected against pulling out. To remove a drawer from the appliance, pull it out as far as it will go, then lift at the front and pull out completely.

# INSTALLATION AND CONNECTION

## SELECTING THE ROOM

- Install the appliance in a dry and well ventilated room. The appliance will operate correctly if the environment temperature is in the interval specified in the table. The appliance class is indicated on the rating plate / label with the basic information on the appliance.

Class	Temperature
SN (subnormal)	from +10°C to +32°C
N (normal)	from +16°C to +32°C
ST (subtropical)	from +16°C to +38°C
T (tropical)	from +16°C to +43°C

**Warning:** Make sure the room where the appliance is installed is large enough. There should be at least 1 m<sup>3</sup> of space per 8 grams of refrigerant. Amount of refrigerant is stated on the rating plate in the appliance interior.

## INSTALLING THE APPLIANCE

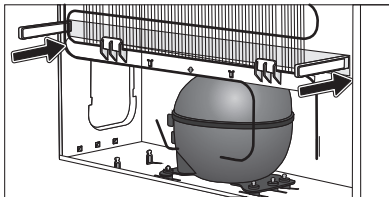
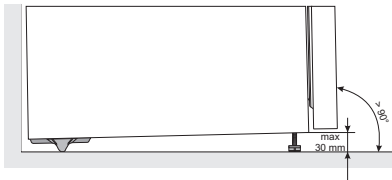

Appliance installation should be carried out by at least two persons to avoid any physical injury or damage to the appliance.

- The appliance must stand level or tilted slightly to the back, stable on a solid base. At the front, the appliance is fitted with two adjustable legs that can be used to level the appliance. At the rear side, casters allow for easier installation of the appliance (only with some models).
- There should be a clearance of at least 5 cm between the appliance and any cupboard installed above it, in order to allow adequate cooling of the condenser unit.
- The appliance is supplied with two spacers which should be installed on the lower part of the housing to prevent from pushing the appliance too close to the wall. Appliance may also be installed without the spacers; however, this may increase power consumption.

- Do not expose the appliance to direct sunlight and do not place it near any source of heat. If this cannot be avoided, install an insulation panel.
- The appliance may stand alone or it may be placed ext to a cupboard or a wall. Consider the clearance required to fully open the door in order to allow pulling out the drawers and shelves (see installation diagram).

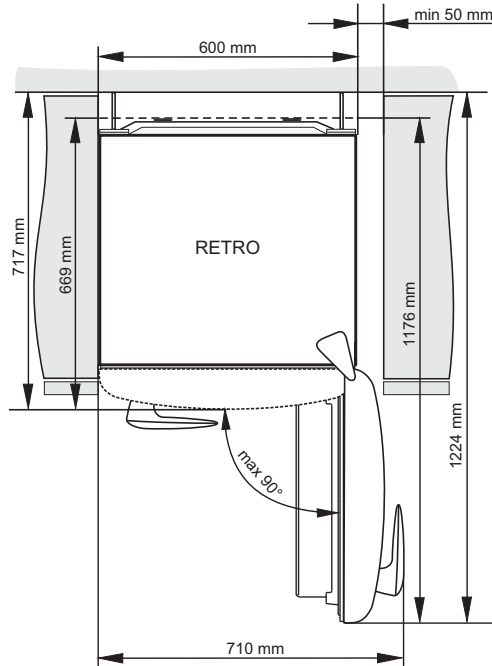

## CONNECTING THE APPLIANCE

- Connect the appliance to the power mains using a connection cable. The wall outlet should be fitted with a ground contact (safety socket). Nominal voltage and frequency are indicated on the rating plate/label with basic information on the appliance.
- The appliance must be connected to the power mains and grounded in compliance with the effective standards and regulations. The appliance will withstand short-term deviations from the nominal voltage, but not more than +/- 6%.

# CHANGING THE DIRECTION OF DOOR OPENING



At RETRO appliances alteration of door opening direction is not possible.

## CHANGING THE DIRECTION OF LOW TEMPERATURE COMPARTMENT DOOR OPENING

1. Undo the latch A and door hinge B of the low temperature compartment and remove the door C.
2. Rotate the door by 180°, mount them on the other side of the low temperature compartment, and attach the latch A and door hinge B to the other side of the cell.
3. Cover the holes left in the cell with the plugs supplied in the bag.
4. Check the door seal. If the seal does not fully fit the door, remove it and rotate it by 180°.

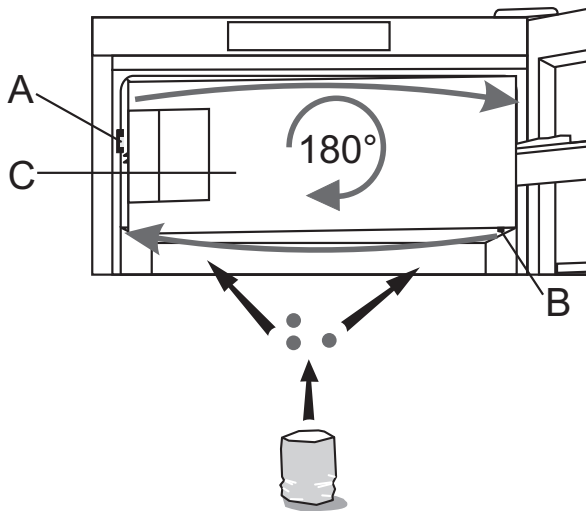

# OPERATING THE APPLIANCE

---

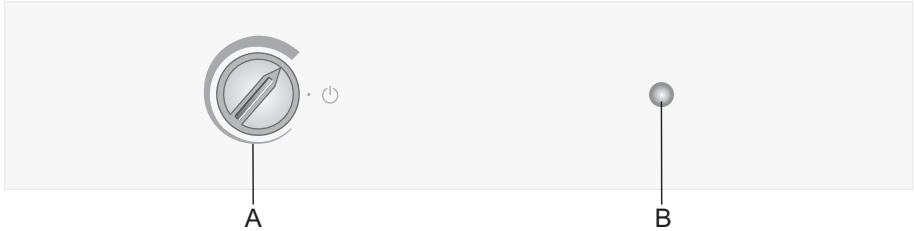

**A** Temperature setting and on/off knob

**B** Lighting on/off key

## SWITCHING THE APPLIANCE ON/OFF

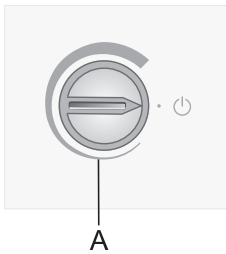

**To switch on:** rotate the **A** dial clockwise.

**Switching off:** Rotate the **A** knob back to the position in which the arrow is aligned with the symbol  (caution: appliance will remain powered, i.e. there will still be electric current in the appliance).

## ADJUSTING THE TEMPERATURE

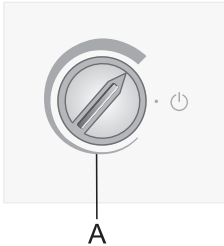
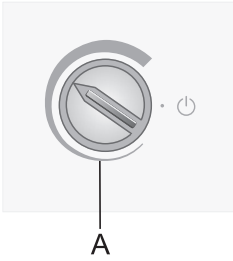

- To set the desired temperature, rotate the **A** dial in clockwise direction, i.e. to the right.
- A change in the environment temperature will affect the temperature in the appliance. Adjust the setting with the **A** dial accordingly. Positions towards the **thicker part** of the sign mean a lower temperature in the appliance (cooler). Settings towards the **thinner part of the sign** mean a higher temperature (warmer).
- If the temperature of the room where the appliance is installed is below 16°C, we recommend setting the **A** dial temperature to **the thickest part of the sign**.



# APPLIANCE INTERIOR EQUIPMENT

(\* Equipment depends on the model)

## SHELF

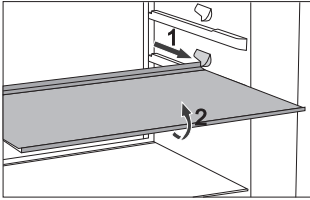

- For easier access to food and clarity, the shelves can be partly pulled out.
- The shelves may be adjusted to suit your preferences using the guides in the refrigerator interior. To remove a shelf from the refrigerator, pull it out to the point when it is stopped by the guide. Then, lift it slightly at the front part and pull it all the way out. Store perishables at the back of the shelf where the temperature is the lowest.

## WIRE BOTTLE RACK\*

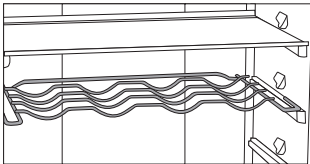

- Some models also feature a wire bottle holder. The bottle holder is protected against being inadvertently pulled out it can only be pulled out when it is empty. To pull it out, lift it slightly at the back and pull it towards you. Place the bottle holder so that the length of the bottles does not prevent proper closing of the door. The holder can take a maximum load of 9 0.75-liter bottles or 13 kilograms of total weight – see label on the right side in the appliance interior.
- Cans may also be placed on the bottle rack (lengthwise or crosswise).

## ELASTIC BOTTLE MAT\*

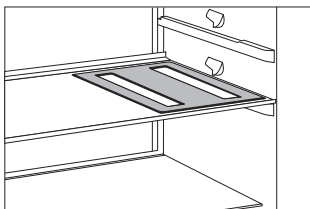

- Some models feature an elastic mat on which bottles or cans can be placed.
- The mat can also be used as a trivet for hot pans.

# CRISPZONE - FRUIT AND VEGETABLE BIN WITH HUMIDITY CONTROL

- The bin at the bottom of the refrigerator is intended for storing fruit and vegetables. It provides humidity and prevents the food from drying out.
- Store the food in suitable packaging to prevent them from emitting or taking on odours. The bin has integrated humidity regulator which allows setting the humidity according to the amount of food stored.

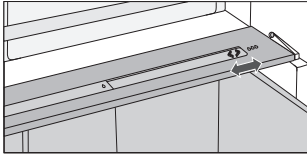

**Smaller amounts of food** - push the control slider to the right;

**Larger amounts of food** - push the control slider to the left;

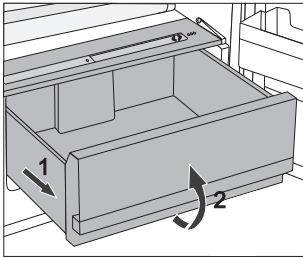

- Pulling out the bin:
  - Pull out the bin as far as it will go.
  - Then, lift the front part and pull it out completely.

## INTERIOR SIDE OF THE REFRIGERATOR DOOR

Mounted on the refrigerator door are compartments (shelves or bins) intended for storing cheese, butter, eggs, yoghurt and other smaller packages, tubes, cans, etc. There is a bottle shelf at the lower end of the door.

## ADJUSTABLE DOOR BINS

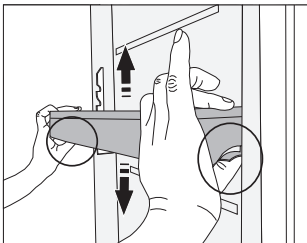

The height of door bins/shelves can be adjusted to your preferences without having to take them out of the appliance. Squeeze the tabs on both sides and move the bin/shelf up or down.

To remove a bin from the appliance, lift it as far as it will go and pull it out.

## STORAGE BIN (MULTIBOX)\*

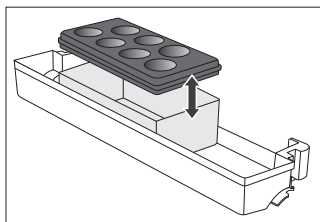

- **MultiBox** bin offers a convenient way for storing food with a strong or pungent smell, e.g. ripened or blue-vein cheese, sausages, onions, butter etc.
  - The silicone lid provides an air-tight seal that prevents the food from drying out and the odour to spread throughout the refrigerator compartment.
  - The silicon lid can also be used as an egg tray.
- If the flexible lid is used as an egg tray, place it directly on the bottom of the door bin and use the open lower part of the Multibox bin to store food in smaller packages – pâté, jams, smaller tubes etc.

## FAN\*

- The fan contributes to more even temperature distribution and faster cooling, and reduces dew (or condensate) accumulation on the storage surfaces.
- Activating the fan is recommended as an extra function in the following cases:
  - when the room temperature is higher (over 30 °C);
  - when humidity is higher or when dew (condensate) is accumulated on the shelves;
  - when inserting a large amount of food (rapid cooling).

**Note:** When the fan is activated, power consumption is increased, temperature in the refrigerator is lowered, and as a result, the temperature in the freezer changes as well. To maintain the same temperature in the refrigerator compartment as before the fan was activated, rotate the A knob slightly towards the thinner part of the sign.

Adjustment of temperature in the refrigerator directly affects the freezer temperature.

## Switching the fan on and off

ON =  OFF = 

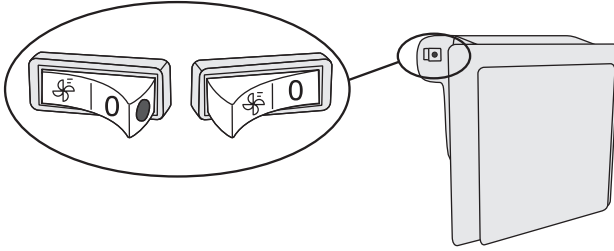

When the fan and the ionizer are switched on, a red dot will be visible on the switch.

# RECOMMENDED DISTRIBUTION OF FOOD IN THE APPLIANCE

---

## Refrigerator compartment areas:

- **upper area:** canned / preserved food, bread, wine, pastry, etc.
- **medium area:** dairy products, ready-to-eat meals, desserts, juices, beer, cooked food, etc.
- **lower area:** meat, meat produce, delicatessen, etc.
- **vegetable drawer / bin:** fresh fruit, vegetables, salads, root vegetables, potatoes, onions, garlic, tomatoes, tropical fruit, sauerkraut, turnips, etc.

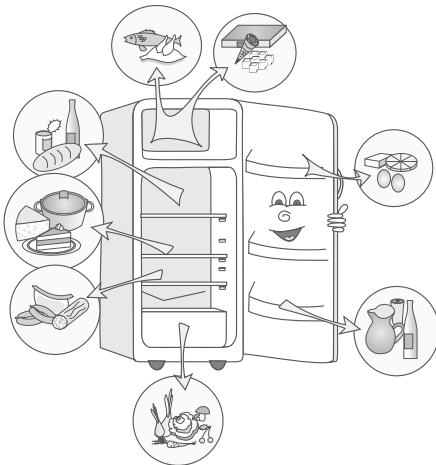

## Refrigerator door areas:

- **upper / medium part:** eggs, butter, cheeses, etc.
- **lower part:** beverages, cans, bottles, etc.

## Freezer compartments:

- freezing, storage of frozen food (see section Freezing and storage of frozen food).

# STORING FOOD IN THE REFRIGERATOR

---

## IMPORTANT WARNINGS REGARDING FOOD STORAGE



Correct use of the appliance, appropriate packaging, maintaining the right temperature, and observing the food hygiene standards has a decisive impact on the quality of food storage.

Observe the expiry dates for the food, specified on the packaging.

Food stored in the refrigerator should be kept in closed containers or appropriate packaging to prevent them from emitting or receiving odours.

Do not store inflammable, volatile, and explosive substances in the refrigerator.

Bottles with high alcohol content should be tightly sealed and stored in an upright position.

Some organic solutions, essential oils in lemon and orange peel, butter acid, etc. may damage the plastic surfaces in case of a prolonged contact, causing damage and premature ageing of these materials.

Unpleasant odour warns of lacking cleanliness of the appliance or perished contents (see Cleaning the Appliance).

If you are leaving home for a longer period of time, remove perishables from the refrigerator.

## FOOD STORAGE TIMES

Recommended storage time in the refrigerator

Type of food	Time
eggs, marinades, smoked meat	up to 10 days
cheese	up to 10 days
root vegetables	up to 8 days
butter	up to 7 days
deserts, fruit, ready-to-eat food, chunks of raw meat	up to 2 days
fish, raw minced meat, seafood	up to 1 day

# STORING FOOD IN THE FRESHZONE DRAWER

---

In the **FreshZone** compartment, food stays fresh longer than in a conventional refrigerator, retaining more flavour and nutrients.

Decay and loss of mass are slowed down; therefore, fruit and vegetables remain fresh and natural longer.

For optimum performance, the drawer should be fully closed.

- When buying food, make sure it is fresh as this will determine the quality of the food, as well as how long it will keep in the fridge.
- Store the food in closed containers or appropriate packaging to prevent them from emitting or receiving odours.
- Take the food from the drawer 30-60 minutes before use to allow the aroma and flavour develop at room temperature.
- Food sensitive to low temperature and not appropriate for storage in the **FreshZone** drawer include the following: pineapple, avocado, bananas, olives, potatoes, eggplant, cucumbers, beans, peppers (capsicum), melons, watermelons, pumpkins, squash, zucchini etc.

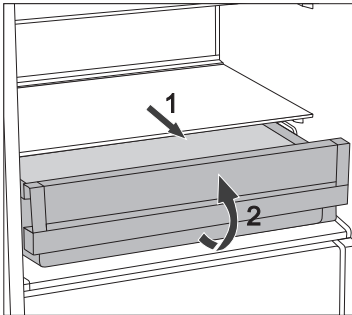

- To remove the drawer:
  - Pull out the drawer until it is blocked.
  - Then, lift it at the front and pull it all the way out.

# FREEZING AND STORING FROZEN FOOD

---

## FREEZING PROCESS



Maximum amount of fresh food that may be inserted at once is specified on the appliance rating plate. If the amount of food to be frozen exceeds the indicated amount, the quality of freezing will be inferior; in addition, the quality of the food already frozen will deteriorate.

- Activate the super freeze function 24 hours before freezing fresh food:
  - rotate the **A** dial towards the **thickest part of the marking**;

Make sure the fresh food is not in contact with the food that is already frozen!

- When freezing smaller quantities of food (1-2 kilograms), activating the super freeze function is not required.
- After the freezing process is completed, rotate the **A** dial back to the desired setting.

## IMPORTANT WARNINGS ON FREEZING FRESH FOOD



Only freeze the food that is suitable for freezing in the freezer. Make sure the food you freeze is of high quality and fresh.

Choose appropriate packaging and use the packaging correctly.

Packaging should not be permeable to humidity; it should be airtight to prevent the food from drying out and loss of vitamins.

Label the food; indicate the type of food, amount, and date of freezing.

It is important that the food is frozen as quickly as possible. Therefore, keep the packages small. Refrigerate the food before freezing.



# AVOID CONTAMINATION OF FOOD

To avoid contamination of food, please respect the following instructions:

- Opening the door for long periods can cause a significant increase of the temperature in the compartments of the appliance.
- Regularly clean surfaces that can come in contact with food and accessible drainage systems.
- Store raw meat and fish in suitable containers in the refrigerator, so that it is not in contact with or drip onto other food.
- If the refrigerating appliance is left empty for long periods, switch off, defrost, clean, dry, and leave the door open to prevent mould developing within the appliance.

# STORAGE OF INDUSTRIALLY FROZEN FOOD

- When storing and using frozen food, observe the manufacturer's instructions. Temperature and expiry date are indicated on the packaging.
- Only choose food with undamaged packaging, stored in freezers at temperatures of -18°C or lower.
- Do not purchase food covered in frost as this indicates they have been partly defrosted several times and that they are of inferior quality.
- Protect the food from thawing during transport. In case of an increase in temperature, storage time will be shorter and quality will deteriorate.

# FROZEN FOOD STORAGE TIME

## Recommended storage time in the freezer

Type of food	Time
fruit, beef	from 10 to 12 months
vegetables, veal, poultry	from 8 to 10 months
Venison	from 6 to 8 months
Pork	from 4 to 6 months
minced meat	4 months
bread, pastry, ready-to-eat meals, lean	3 months
entrails	2 months
smoked sausage, fatty fish	1 month

# DEFROSTING FROZEN FOOD

Freezing the food does not kill the microorganisms. After the food is defrosted or thawed, bacteria is re-activated and the food spoils quickly. Use the partially or completely defrosted food as soon as possible.

Partial thawing decreases the nutritive value of the food, particularly fruit, vegetables, and ready-to-eat food.

# DEFROSTING THE APPLIANCE

---

## AUTOMATIC REFRIGERATOR DEFROSTING

Refrigerator does not need defrosting because the ice on the back interior wall is thawed automatically.

Any accumulated ice will melt when the compressor unit is inactive. Drops will flow through an opening in the refrigerator rear wall into a tray fitted above the compressor, from where they will evaporate.

If an excessive layer of ice is formed on the rear wall of refrigerator interior (3-5 mm), switch off the appliance and defrost the appliance manually.

## DEFROSTING A CONVENTIONAL FREEZER

- Defrost the freezer when an approximately 3-5 millimeter layer of frost or ice has built up.
- 24 hours before defrosting, activate the super freeze function to additionally cool the food (see section »Freezing Process«).

After this period, remove the food from the freezer and protect them from defrosting.

- Switch off the appliance (see chapter Switching the appliance on/off) and unplug the power cord.
- Do not use any defrosting sprays as they may melt the plastic parts or harm your health.
- Do not use a knife or any other sharp object to remove the frost, because you may damage a pipe of the cooling system.
- To speed up the defrosting process, place a pot of hot water on the glass shelf.
- Clean and dry the appliance interior (see Cleaning the Appliance).
- Before placing the food into the freezer, switch on the appliance and rotate the **A** dial back to the desired setting.

# CLEANING THE APPLIANCE

Before cleaning, unplug the appliance from the power mains – switch off the appliance (see chapter Switching the Appliance On/Off) and unplug the power cord from the wall outlet.

- Use a **soft cloth** to clean all surfaces. Cleaners that contain **abrasive substances, acids, or solvents are not suitable for cleaning** as they may damage the surface.

Clean the appliance **exterior** with water or a mild solution of suds. Lacquer-coated and aluminium surfaces may be cleaned with lukewarm water to which you have added a mild detergent. Use of cleaners with low alcohol content is allowed (e.g. window cleaners). Do not use cleaners containing alcohol for cleaning plastic materials.

**Appliance interior** can be cleaned with lukewarm water to which you can add some **vinegar**.

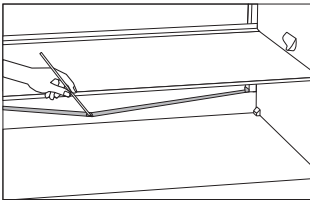

- A gutter and an opening through which the water from thawed ice flows are located underneath the cooling panel that cools the refrigerator interior. The gutter and the opening may not be clogged. Inspect them often and clean if necessary (e.g. with a plastic straw).
- Frost or ice build-up, 3-5 mm thick, will increase power consumption. Therefore, it should be regularly removed. Do not use any sharp objects, solvents, or sprays.

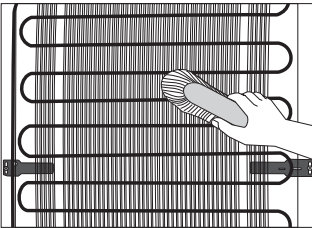

- The **condenser** unit mounted on the (exterior) back wall should always be kept clean, free of dust or deposits resulting from kitchen smoke or fumes.. Occasionally clean the dust using a soft non-metal brush or a vacuum cleaner.
- After cleaning, switch the appliance back on and insert the food.

# TROUBLESHOOTING

Problem:	Cause or remedy:
Appliance is connected to the power mains but it does not work.	<ul style="list-style-type: none"> <li>• Make sure there is voltage in the power outlet and that the appliance is switched on.</li> </ul>
Cooling system operates continuously for a long period of time:	<ul style="list-style-type: none"> <li>• Too high environment temperature.</li> <li>• Door opened too frequently or too long.</li> <li>• Door not closed correctly (possible impurities on the seal, misaligned door, damaged seal etc.).</li> <li>• Too much fresh food inserted at once.</li> <li>• Insufficient compressor and condenser cooling. Check the air circulation behind the appliance and clean the condenser unit.</li> </ul>
Excessive build-up of ice on the back wall of refrigerator interior can be a result of the following:	<ul style="list-style-type: none"> <li>• Door opened too frequently or too long.</li> <li>• Warm food placed in the refrigerator.</li> <li>• Food in contact with the back interior wall of the refrigerator.</li> <li>• Poor door sealing.</li> <li>• If the seal is dirty or damaged, clean it or replace it.</li> </ul>
Condensate (dew) on the shelf above the drawers:	<ul style="list-style-type: none"> <li>• This is a transient phenomenon which cannot be entirely avoided in periods of high environment temperature and humidity. It subsides when temperature and humidity are normalized. We recommend cleaning the drawers more frequently and wiping the droplets occasionally.</li> <li>• Open the humidity control slider.</li> <li>• Place the food in to bags or other airtight packaging.</li> <li>• Activate the fan to dry the accumulated dew.</li> </ul>
Water leaking from the refrigerator:	<ul style="list-style-type: none"> <li>• Clogged water discharge opening or water dripping past the water gutter.</li> <li>• Clean the clogged opening, for example using a plastic straw.</li> <li>• If a thick layer of ice builds up, defrost the appliance manually (see Defrosting the Appliance).</li> </ul>
LED lighting does not work:	<ul style="list-style-type: none"> <li>• If LED lighting does not work, call a service technician.</li> <li>• Do not attempt a repair of the LED lighting yourself, as there is danger of contact with high voltage!</li> </ul>

If none of the instructions above fixes your problem, call the nearest authorized service center and state the type, model, and serial number found on the rating plate/label which is located in the appliance interior.

# INFORMATION ABOUT APPLIANCE NOISE

---

Cooling in refrigerator freezers is made possible by a cooling system that also includes a compressor (and a fan with some appliances), which generates some noise. The level of noise depends on installation, proper use, and age of the appliance.

- **After connecting the appliance to the power mains**, compressor operation, or the sound of flowing liquid, may be somewhat louder. This is not a sign of malfunction and it will not affect the useful life of the appliance. In time, appliance operation and this noise will become quieter.
- Sometimes, **unusual or loud noise** may appear during appliance operation; these are mostly the result of improper installation:
  - The appliance must stand level and stable on a solid base.
  - The appliance may not be in contact with a wall or adjacent furniture.
  - Make sure the interior equipment sits firmly in its place and that the noise is not caused by cans, bottles or other containers placed next to each other.
- Due to the higher workload on the cooling system when the door is opened more frequently or for a longer time, when a large amount of fresh food is introduced, or when intensive freezing or cooling functions are activated, the appliance can temporarily generate more noise.

WE RESERVE THE RIGHT TO MAKE CHANGES THAT DO NOT AFFECT THE FUNCTIONALITY OF THE APPLIANCE.

**Hisense UK Ltd**

Unit 2 Meadow Court Millshaw Lane Leeds, West Yorkshire, LS11 8LZ,  
United Kingdom

**Hisense France SAS**

9 Rue des 3 Sœurs, 93420 Villepinte, France

**Hisense Germany GmbH**

Garmischer Strasse 4-6, 80339 München, Germany

**Hisense Italia SRL**

Via Montefeltro, 6/A 20156 Milano, Italia

**Hisense Iberia S.L**

Ronda Auguste y Louis Lumiere, 23 Nave 12  
Edificio Lumiere – Parque Tecnológico 46980 Paterna (Valencia). España

**Gorenje gospodinjski aparati, d.o.o.**

Partizanska cesta 12, 3320 Velenje, Slovenia

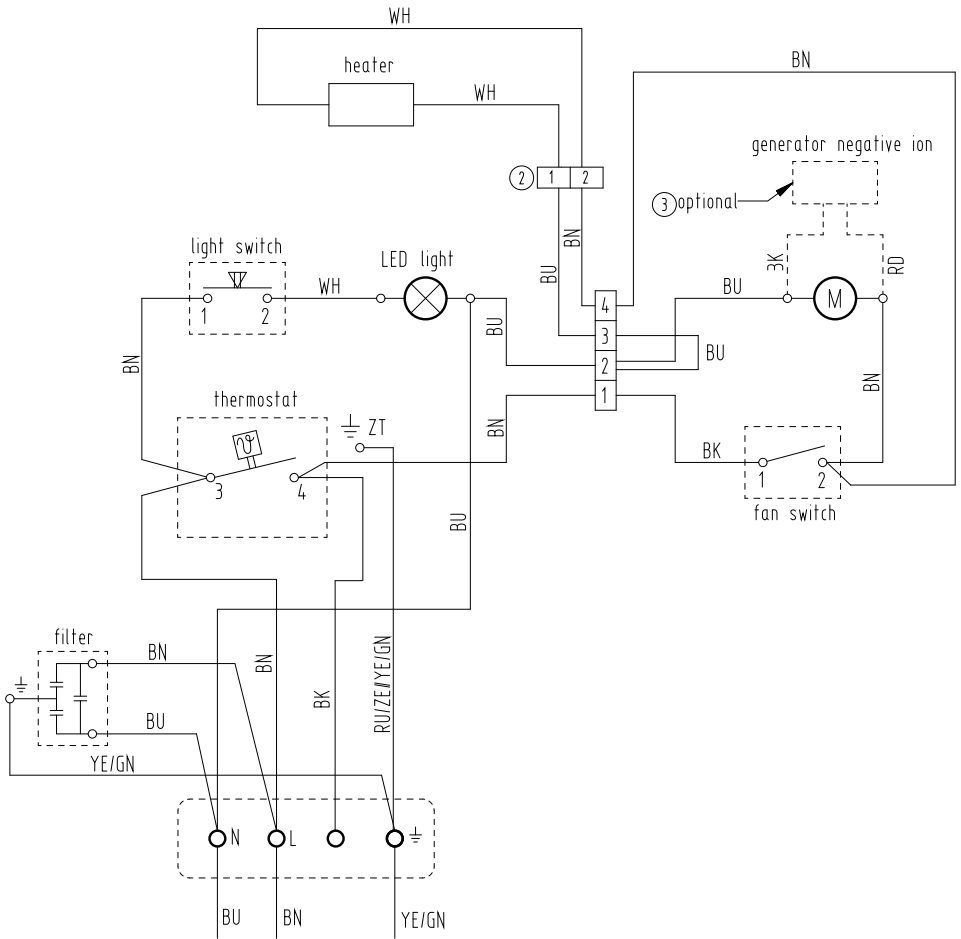

COOLER 4\* FS600 HSN



794211

en (09-20)