

# Hisense

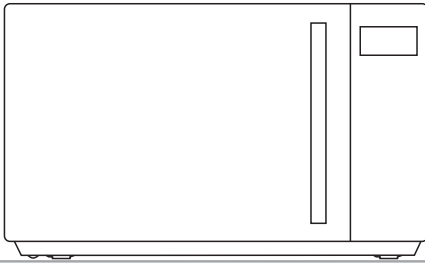

H23MOBS5HCUK



Instruction manual / Microwave oven

**EN** ..... 4

---

## DEAR CUSTOMER

We sincerely thank you for your purchase. We believe you will soon find ample evidence that you can really rely on our products. To make the use of the appliance easier, we attach these comprehensive instruction manual.

The instructions should aid you in getting familiar with your new appliance. Please, read them carefully before using the appliance for the first time.

In any case, please make sure the appliance was supplied to you undamaged. Should you identify and transport damage, contact your sales representative or the regional warehouse from where the product was delivered. You will find the telephone number on the receipt or delivery report.

We wish you a lot of pleasure with your new household appliance.



The appliance for household use for heating food and beverages using electromagnetic energy, for indoor use only.

---

## INSTRUCTIONS FOR USE

These instructions are intended for the user. They describe the cooker and how to use it. They also apply to different types of appliances, therefore you may find some descriptions of functions that may not apply to your appliance.

## PRECAUTIONS TO AVOID POSSIBLE EXPOSURE TO EXCESSIVE MICROWAVE ENERGY

- (a) Do not attempt to operate this oven with the door open since this can result in harmful exposure to microwave energy. It is important not to break or tamper with the safety interlocks.
- (b) Do not place any object between the oven front face and the door or allow soil or cleaner residue to accumulate on sealing surfaces.
- (c) **WARNING:** If the door or door seals are damaged, the oven must not be operated until it has been repaired by a competent person.

### **ADDENDUM**

If the apparatus is not maintained in a good state of cleanliness, its surface could be degraded and affect the lifespan of the apparatus and lead to a dangerous situation.

### **WARNING**

To reduce the risk of fire, electric shock, injury to persons or exposure to excessive microwave oven energy when using your appliance, follow basic precautions, including the following:

- Read and follow the specific: "PRECAUTIONS TO AVOID POSSIBLE EXPOSURE TO EXCESSIVE MICROWAVE ENERGY".
- This appliance can be used by children aged from 8 years and above and persons with reduced physical, sensory or mental capabilities or lack of experience and knowledge if they have been given supervision or instruction concerning use of the appliance in a safe way and understand the hazards involved. Children shall not play with the appliance.  
Cleaning and user maintenance shall not be made by children without supervision.
- Keep the appliance and its cord out of reach of children less than.
- If the supply cord is damaged, it must be replaced by the manufacturer, its service agent or similarly qualified persons in order to avoid a hazard.
- **WARNING:** Ensure that the appliance is switched off before replacing the lamp to avoid the possibility of electric shock.
- **WARNING:** It is hazardous for anyone other than a competent person to carry out any service or repair operation that involves the removal of a cover which gives protection against exposure to microwave energy.
- **WARNING:** Liquids and other foods must not be heated in sealed containers since they are liable to explode.

- When heating food in plastic or paper containers, keep an eye on the oven due to the possibility of ignition.
- Only use utensils that are suitable for use in microwave ovens.
- If smoke is emitted, switch off or unplug the appliance and keep the door closed in order to stifle any flames.
- Microwave heating of beverages can result in delayed eruptive boiling, therefore care must be taken when handling the container.
- The contents of feeding bottles and baby food jars shall be stirred or shaken and the temperature checked before consumption, in order to avoid burns.
- Eggs in their shell and whole hard-boiled eggs should not be heated in microwave ovens since they may explode, even after microwave heating has ended.
- The oven should be cleaned regularly and any food deposits removed.
- Failure to maintain the oven in a clean condition could lead to deterioration of the surface that could adversely affect the life of the appliance and possibly result in a hazardous situation.
- The appliance must not be installed behind a decorative door in order to avoid overheating. (This is not applicable for appliances with decorative door.)
- Only use the temperature probe recommended for this oven. (for ovens provided with a facility to use a temperature-sensing probe.)
- The microwave oven shall not be placed in a cabinet unless it has been tested in a cabinet.
- The microwave oven must be operated with the

decorative door open. (for ovens with a decorative door.)

- This appliance is intended to be used in household a similar applications such as:
  - staff kitchen areas in shops, offices and other working environments;
  - by clients in hotels, motels and other residential type environments;
  - farm houses;
  - bed and breakfast type environments.
- The microwave oven is intended for heating food and beverages. Drying of food or clothing and heating of warming pads, slippers, sponges, damp cloth and similar may lead to risk of injury, ignition or fire.
- Metallic containers for food and beverages are not allowed during microwave cooking.
- The appliance shall not be cleaned with a steam cleaner.
- The appliance is intended to be used freestanding.
- The rear surface of appliances shall be placed against a wall.
- The appliances are not intended to be operated by means of an external timer or separate remote-control system.
- The temperature of accessible surfaces may be high when the appliance is operating.
- **WARNING:** When the appliance is operated in the combination mode, children should only use the oven under adult supervision due to the temperatures generated.

**READ CAREFULLY AND KEEP FOR FUTURE  
REFERENCE  
HOUSEHOLD USE ONLY  
(NOT FOR COMMERCIAL USE)**

## TO REDUCE THE RISK OF INJURY TO PERSONS GROUNDING INSTALLATION

### **DANGER**

#### **Electric Shock Hazard**

Touching some of the internal components can cause serious personal injury or death. Do not disassemble this appliance.

### **WARNING**

#### **Electric Shock Hazard**

Improper use of the grounding can result in electric shock.

Do not plug into an outlet until appliance is properly installed and grounded.

This appliance must be grounded. In the event of an electrical short circuit, grounding reduces the risk of electric shock by providing an escape wire for the electric current.

This appliance is equipped with a cord having a grounding wire with a grounding plug. The plug must be plugged into an outlet that is properly installed and grounded.

Consult a qualified electrician or serviceman if the grounding instructions are not completely understood or if doubt exists as to whether the appliance is properly grounded.

If it is necessary to use an extension cord, use only a 3-wire extension cord.

1. A short power-supply cord is provided to reduce the risks resulting from becoming entangled in or tripping over a longer cord.
2. If a long cord set or extension cord is used:
  - 1) The marked electrical rating of the cord set or extension cord should be at least as great as the electrical rating of the appliance.

- 2) The extension cord must be a grounding-type 3-wire cord.
- 3) The long cord should be arranged so that it will not drape over the counter top or tabletop where it can be pulled on by children or tripped over unintentionally.

Be sure to unplug the appliance from the power supply.

1. Clean the cavity of the oven after using with a slightly damp cloth.
2. Clean the accessories in the usual way in soapy water.
3. The door frame and seal and neighbouring parts must be cleaned carefully with a damp cloth when they are dirty.
4. Do not use harsh abrasive cleaners or sharp metal scrapers to clean the oven door glass since they can scratch the surface, which may result in shattering of the glass.
5. Cleaning Tip---For easier cleaning of the cavity walls that the food cooked can touch: Place half a lemon in a bowl, add 300ml (1/2 pint) water and heat on 100% microwave power for 10 minutes. Wipe the oven clean using a soft, dry cloth.

### **CAUTION**

#### **Personal Injury Hazard**

It is hazardous for anyone other than a competent person to carry out any service or repair operation that involves the removal of a cover which gives protection against exposure to microwave energy. See the instructions on "Materials you can use in microwave oven or to be avoided in microwave oven." There may be certain non-metallic utensils that are not safe to use for microwaving. If in doubt, you can test the utensil in question following the procedure below.

#### **Utensil Test:**

1. Fill a microwave-safe container with 1 cup of cold water (250ml) along with the utensil in question.
2. Cook on maximum power for 1 minute.
3. Carefully feel the utensil. If the empty utensil is warm, do not use it for microwave cooking.
4. Do not exceed 1 minute cooking time.

# Materials you can use in microwave oven

<b>Utensils</b>	<b>Remarks</b>
Browning dish	Follow manufacturer's instructions. The bottom of browning dish must be at least 3/16 inch (5mm) above the turntable. Incorrect usage may cause the turntable to break.
Dinnerware	Microwave-safe only. Follow manufacturer's instructions. Do not use cracked or chipped dishes.
Glass jars	Always remove lid. Use only to heat food until just warm. Most glass jars are not heat resistant and may break.
Glassware	Heat-resistant oven glassware only. Make sure there is no metallic trim. Do not use cracked or chipped dishes.
Oven cooking bags	Follow manufacturer's instructions. Do not close with metal tie. Make slits to allow steam to escape.
Paper plates and cups	Use for short-term cooking/warming only. Do not leave oven unattended while cooking.
Paper towels	Use to cover food for reheating and absorbing fat. Use with supervision for a short-term cooking only.
Parchment paper	Use as a cover to prevent splattering or a wrap for steaming.
Plastic	Microwave-safe only. Follow the manufacturer's instructions. Should be labeled "Microwave Safe". Some plastic containers soften, as the food inside gets hot. "Boiling bags" and tightly closed plastic bags should be slit, pierced or vented as directed by package.
Plastic wrap	Microwave-safe only. Use to cover food during cooking to retain moisture. Do not allow plastic wrap to touch food.
Thermometers	Microwave-safe only ( meat and candy thermometers).
Wax paper	Use as a cover to prevent splattering and retain moisture.

# Materials to be avoided in microwave oven

<b>Utensils</b>	<b>Remarks</b>
Aluminum tray	May cause arcing. Transfer food into microwave-safe dish.
Food carton with metal handle	May cause arcing. Transfer food into microwave-safe dish.
Metal or metaltrimmed utensils	Metal shields the food from microwave energy. Metal trim may cause arcing.
Metal twist ties	May cause arcing and could cause a fire in the oven.
Paper bags	May cause a fire in the oven.
Plastic foam	Plastic foam may melt or contaminate the liquid inside when exposed to high temperature.
Wood	Wood will dry out when used in the microwave oven and may split or crack.

# NAMES OF OVEN PARTS AND ACCESSORIES

(In case of any differences between the appliance and the pictures in this manual, the product shall prevail.)

Remove the oven and all materials from the carton and oven cavity.  
Your oven comes with the following accessories:

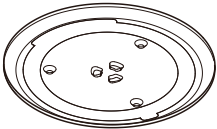

Glass Tray

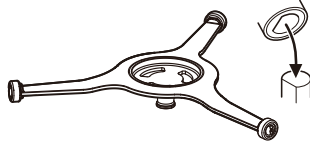

Turntable Ring Assembly

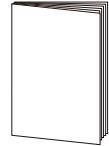

Instruction Manual

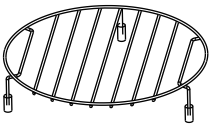

Lower Grill Rack ( Can not be used in microwave function and must be placed on the glass tray

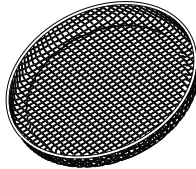

Bake basket ( Can not be used in microwave function and must be placed on the glass tray )

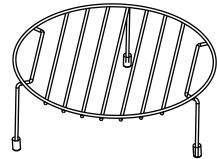

Higher Grill Rack( Can not be used in microwave function and must be placed on the glass tray )

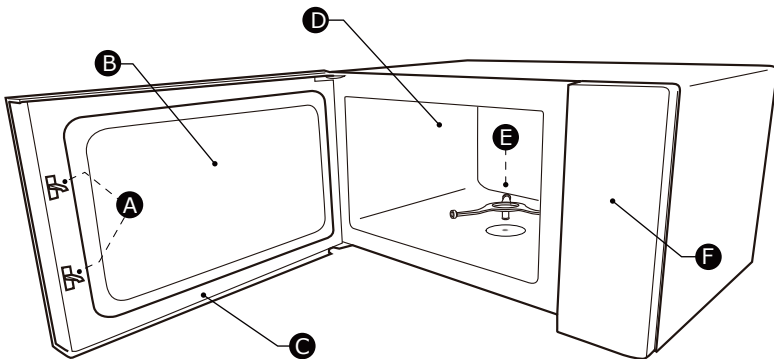

A) Safety interlock system  
B) Observation window  
C) Door assembly

D) Oven cavity  
E) Turntable Ring Assembly  
F) Control panel

Cleaning the cooking compartment and putting the turntable in place.

For new installations, make sure all packaging and shipping tape has been removed. Before using the appliance to prepare food for the first time, you will need to put the turntable in place correctly.

You must clean the cooking compartment and accessories.

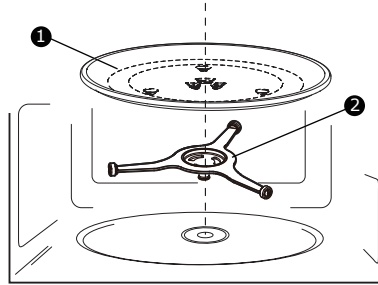

1) Glass Tray

2) Turntable Ring Assembly

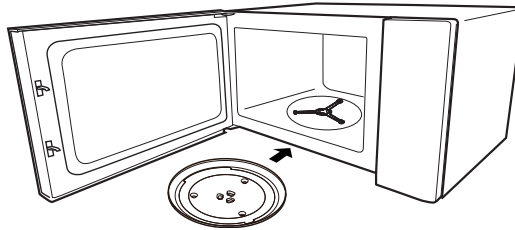

#### **NOTES:**

1. Never use the appliance without the turntable. Make sure that it is properly engaged. The turntable can turn clockwise or anti-clockwise.
2. Never place the glass tray upside down. The glass tray should never be restricted.
3. Both glass tray and turntable ring assembly must always be used during cooking.
4. All food and containers of food are always placed on the glass tray for cooking.
5. Never restrict the movement of the turntable.
6. If glass tray or turntable ring assembly cracks or breaks, contact your nearest authorized service center.

#### **Countertop Installation**

Remove all packing material and accessories.

Examine the oven for any damage such as dents or broken door.

Do not install if oven is damaged.

Cabinet: Remove any protective film found on the microwave oven cabinet surface.

Do not remove the waveguide cover that is attached to the oven cavity to protect the magnetron.

# INSTALLATION

1. Select a level surface that provide enough open space for the intake and/or outlet vents.

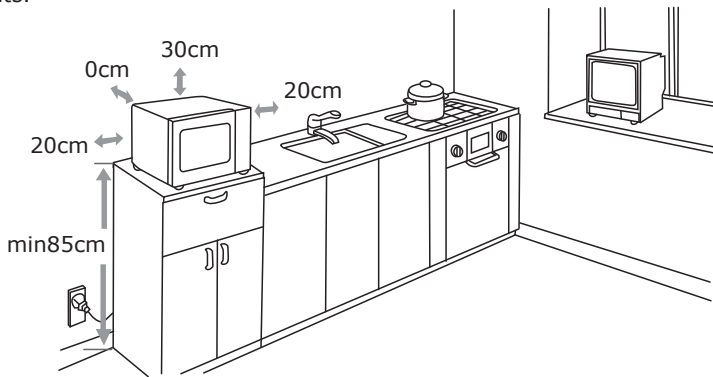

- (1) The minimum installation height is 85cm.
  - (2) The rear surface of appliance shall be placed against a wall.  
Leave a minimum clearance of 30cm above the oven, a minimum clearance of 20cm is required between the oven and any adjacent walls.
  - (3) Do not remove the legs from the bottom of the oven.
  - (4) Blocking the intake and/or outlet openings can damage the oven.
  - (5) Place the oven as far away from radios and TV as possible. Operation of microwave oven may cause interference to your radio or TV reception.
2. Plug your oven into a standard household outlet.  
Be sure the voltage and the frequency is the same as the voltage and the frequency on the rating label.

**WARNING:** Do not install oven over a range cooktop or other heat-producing appliance. If installed near or over a heat source, the oven could be damaged and the warranty would be void.

The accessible surface may be hot during operation.



# CONTROL PANEL



# OPERATION INSTRUCTION

## Setting the Clock

1. Press " CLOCK SETTING" once, and then "00:00" will display.
2. Press the number keys to enter the time.  
Example: To set the clock to 10:20, please press "1,0,2,0" in turn.
3. Press " CLOCK SETTING" to confirm. The clock is set.

### Notes:

- 1) The clock is a 24-hour display. If the clock is not set, it will not work when powered.
- 2) To reset the clock, please repeat step 1 to step 3.

## Setting the Kitchen Timer

1. Press " CLOCK SETTING" twice, and then "00:00" will display.
2. Press the number keys to set the desired time.  
The maximum timer value is "99:99".
3. Press " START/+30SEC " to confirm.  
The timer starts counting down.

### Note:

The kitchen timer is a timer.

## Microwave Cooking

### 11 power levels are available.

Level	11	10	9	8	7	6	5	4	3	2	1
Power	100%	90%	80%	70%	60%	50%	40%	30%	20%	10%	0%
Display	PL10	PL09	PL08	PL07	PL06	PL05	PL04	PL03	PL02	PL01	PL00

1. Press " POWER LEVEL " once, and then "PL10" will display.
2. Press " POWER LEVEL " repeatedly to set the power level.  
The 11 power levels are available.
3. Press " COOKING TIME " once, and then press the number keys to set the cooking time.  
The maximum time value is "99:99".
4. Press " START/+30SEC " to start cooking.

### Note:

Opening the oven door or pressing " STOP/CANCEL " during operation will interrupt the current mode.

## Grill or Combi. Cooking

1. Press " GRILL COMBI " repeatedly to select the cooking mode, and then "G"(grill), "C-1", "C-2", "C-3", "C-4" will display in order.
2. Press the number keys to set the cooking time. The maximum time value is "99:99" .
3. Press " START/+30SEC " to start cooking.

### Grill & Combination instructions

Instructions	Display	Microwave	grill	Convection
1	G		●	
2	C-1	●		●
3	C-2	●	●	
4	C-3		●	●
5	C-4	●	●	●

### Note:

The buzzer will sound to remind of turning over the food during grill cooking.

If no operation, the oven will continue working.

## Convection Cooking (with preheating & without preheating)

1. Press " AIR FRY. " once, and then "Con" will display.
2. Press " AIR FRY. " repeatedly to set the temperature. 10 options are available including "110, 120, 130, 140, 150, 160, 170, 180, 190, 200"°C.
3. Press " START/+30SEC " to confirm the temperature.
4. Press " START/+30SEC " again to start preheating. When preheating is completed, the oven will beep twice. Open the door and place food in the oven. Then close the door.  
(If preheating is not needed, please skip this step and press " COOKING TIME " once.)
5. Press the number keys to set the cooking time. The maximum time value is "99:99".
6. Press " START/+30SEC " to start cooking.

## Defrost by Weight

1. Press " DEFROST " once, and then the screen will display "d-1".
2. Press the number keys to set the weight of the food. The range of weight is 100-2000g.
3. Press " START/+30SEC " to start defrosting.

### Note:

The buzzer will sound to remind of turning over the food during defrosting.

If no operation, the oven will continue working.

---

## Defrost by Time

1. Press " DEFROST " twice, and then the screen will display "d-2".
2. Press the number keys to set the desired defrost time. The maximum time value is "99:99".
3. Press " START/+30SEC " to start defrosting.

### **Note:**

The default power level is PL03 and it cannot be changed during defrosting.

---

## Memory Function

You can save the settings for a dish in the memory and call it up again.

1. Press " 0 " repeatedly to select memory 1-3 procedure. "1", "2" and "3" will display in order.
2. If the procedure has been set, press " START/+30SEC " to start working. Otherwise, please continue to set.
3. After finishing the setting, press " START/+30SEC " once to save the procedure.

Example: Set memory 2 (cook food with 80% microwave power for 3 minutes).

- (1) In standby mode, press " 0 " twice.
- (3) Press " POWER LEVEL " repeatedly till "PL08" displays.
- (2) Press " COOKING TIME " once and then press number keys "3", "0", and "0" in order.
- (4) Press " START/+30SEC " to save the setting and "2" will display.

### **Notes:**

- 1) If the power is not cut off, the procedure will be saved all the time.
- 2) The convection with preheating and the auto menu cannot be set as a memory function.

---

## Multi-Stage Cooking

### **Notes:**

- 1) Two cooking stages can be set in multi-stage cooking.
- 2) If you set the defrost function, it will work automatically in the first stage.
- 3) The kitchen timer, auto menu, speedy cooking and preheating cannot be set as one of the multi-stage.

Example: Defrost food for 5 minutes and then cook with 80% microwave power for 7 minutes.

- (1) Press " DEFROST " twice and then the screen will display "d-2".

- (2) Press "5", "0", and "0" to set the desired defrost time to 5 minutes.
- (3) Press " POWER LEVEL " once and then "PL10" will display.
- (4) Press " POWER LEVEL " repeatedly to set the power level to PL08.
- (5) Press " COOKING TIME " once and then press "7", "0", and "0" to set the cooking time.
- (6) Press " START/+30SEC " to start cooking.

---

### Speedy Cooking

1. In standby mode, press " START/+30SEC " to cook food with 100% power level for 30 seconds. Each press on the same key can increase 30 seconds and the maximum time value is "99:99".
2. In standby mode, pressing the number keys 1 to 6 lets you quickly select a cooking time from 1 to 6 minutes. Then you can press " START/+30SEC " to increase the cooking time.  
The maximum time value is "99:99".

#### **Note:**

In the cooking state and defrosting by time state, each one more press on " START/+30SEC " can increase the cooking time by 30 seconds (except the defrost by weight and the auto menu function).

---

### Lock Function for Children

You can use this function to prevent children from accidentally turning the appliance on.

To activate the lock:

In standby mode, press and hold " STOP/CANCEL " for three seconds. A beep sounds.  
the locked icon will display.

To deactivate the lock:

In the locked state, press and hold " STOP/CANCEL " for three seconds. A beep sounds.

---

### ECO Function

To enter ECO mode:

In standby mode, press " STOP/CANCEL " once, or if there is no operation within 10 minutes, the screen will turn off.

To cancel ECO mode:

In ECO mode, pressing any key, or opening and closing the door will cancel it.

---

## Inquiring Function

1. If the clock has been set, the current time will display for three seconds by pressing " CLOCK SETTING " in the cooking state.
2. In the microwave cooking state, press " POWER LEVEL " to inquire about the power level. It will display for three seconds. In the grilling state, combination cooking state, and convection cooking state, press " GRILL COMBI " or " AIR FRY. " to inquire about the cooking mode.

---

## Mute mode

To activate the mute mode:

In standby mode, press and hold " CLOCK SETTING " for 3 seconds.

When you press the key, it does not make a sound.

To deactivate the mute mode:

In mute mode, press and hold " CLOCK SETTING " for 3 seconds. The buzzer will sound.





---

---

## Auto Menu

1. Press the corresponding menu key repeatedly to set the weight of the food.
2. Press " START/+30SEC " to start cooking.  
For example, cooking 2 potatoes as follows:
  1. Press "  " twice, "2" displays.
  2. Press " START/+30SEC " to start cooking.

## Auto Menu Chart

Menu	Weight	Display	Power
 POTATO	1(230g)	1	PL10
	2(460g)	2	
	3(690g)	3	
 FROZEN PIZZA	100g	100g	Conv.200°C
	200g	200g	
	350g	350g	
 VEGETABLE	150g	150g	PL10
	350g	350g	
	500g	500g	
 SOUP	200g	200g	PL10
	400g	400g	
	600g	600g	
 MEAT	150g	150g	PL08
	300g	300g	
	450g	450g	
	600g	600g	

### Air fry Menu

For air fry cooking you will need to select & confirm the type of food.

Please refer to the chart below.

1. Press "  " repeatedly to choose the desired menu, and "H1~H9" will display in order.
2. Press " START/+30SEC " to start cooking.

### Air fry Menu Chart

Display	Air fry Menu	Weight	Power
H1	Frozen French fries	300g	Conv.210°C
H2	Frozen Potato croquettes	350g	
H3	Frozen Squid	300g	
H4	Frozen Onion rings	250g	
H5	Frozen chicken nuggets	350g	
H6	Escalope	400g	
H7	Shrimps	250g	
H8	Vegetable	200g	
H9	Spring rolls	300g	

**Note:**

For the menu " H1", "H5", "H6", "H9", the buzzer will sound to remind of turning over the food during cooking. If no operation, the oven will continue working.

**SPECIFICATIONS**

Model .....H23MOBS5HCUK  
 Rated Voltage .....230V~50 Hz  
 Microwave Input .....1450W  
 Microwave Output ..... 900W  
 Grill ..... 1000W  
 Convection ..... 1680W

**ENERGY CONSUMPTION**

Product information for power consumption and maximum time to reach applicable low power mode.

Off mode	0.5 W
Standby mode	0.8 W

The maximum time needed for the microwave oven to automatically reach the applicable low power mode or condition. 20 minutes

# TROUBLE SHOOTING

Normal	
Microwave oven interfering TV reception	Radio and TV reception may be interfered when microwave oven operating. It is similar to the interference of small electrical appliances, like mixer, vacuum cleaner, and electric fan. It is normal.
Dim oven light	In low power microwave cooking, oven light may become dim. It is normal.
Steam accumulating on door, hot air out of vents	In cooking, steam may come out of food. Most will get out from vents. But some may accumulate on cool place like oven door. It is normal.
Oven started accidentally with no food in.	It is forbidden to run the unit without any food inside. It is very dangerous.

Trouble	Possible Cause	Remedy
Oven cannot be started.	(1) Power cord is not plugged in tightly.	Unplug. Then plug again after 10 seconds.
	(2) Fuse blowing or circuit breaker works.	Replace fuse or reset circuit breaker (repaired by professional personnel of our company)
	(3) Trouble with outlet.	Test outlet with other electrical appliances.
Oven does not heat.	(4) Door is not closed well.	Close door well.



According to Waste of Electrical and Electronic Equipment (WEEE) directive, WEEE should be separately collected and treated. If at any time in future you need to dispose of this product please do NOT dispose of this product with household waste. Please send this product to WEEE collecting points where available.

## BEFORE YOU CALL FOR SERVICE

1. If the oven will not perform at all, the information on the display does not appear or the display disappeared:
  - a) Check to ensure that the oven is plugged in securely. If it is not, remove the plug from the outlet, wait 10 seconds and plug it in again securely.
  - b) Check the premises for a blown circuit fuse or a tripped main circuit breaker. If these seem to be operating properly, test the outlet with another appliance.
2. If the microwave power will not function:
  - a) Check to see whether the timer is set.
  - b) Check to make sure that the door is securely closed to engage the safety interlocks. Otherwise, the microwave energy will not flow into the oven.  
**If none of the above rectify the situation, then contact the nearest authorized service agent.**

**The appliance for household use for heating food and beverages using electromagnetic energy, for indoor use only.**

## GUARANTEE & SERVICE

If you need information or if you have a problem, please contact the Hisense Customer Care Centre in your country (you find its phone number in the worldwide guarantee leaflet). If there is no Customer Care Centre in your country, go to your local Hisense dealer or contact the Service department of Hisense domestic appliances.

### **For personal use only!**

Additional recommendations for cooking with microwave and useful advices can be found on web side:

<http://www.hisense.com>

**WISHES YOU A LOT OF PLEASURE WHILE USING YOUR APPLIANCE**

**Hisense**  
life reimagined

