

Instructions for Installation and Use

Built-in double oven

SAFETY INSTRUCTIONS

Before using the appliance, read these safety instructions. Keep them nearby for future reference.

These instructions and the appliance itself provide important safety warnings, to be observed at all times. The manufacturer declines any liability for failure to observe these safety instructions, for inappropriate use of the appliance or incorrect setting of controls.

⚠ Very young children (0-3 years) should be kept away from the appliance. Young children (3-8 years) should be kept away from the appliance unless continuously supervised. Children from 8 years old and above and persons with reduced physical, sensory or mental capabilities or lack of experience and knowledge can use this appliance only if they are supervised or have been given instructions on safe use and understand the hazards involved. Children must not play with the appliance. Cleaning and user maintenance must not be carried out by children without supervision.

⚠ **WARNING:** The appliance and its accessible parts become hot during use. Care should be taken to avoid touching heating elements. Children less than 8 years of age must be kept away unless continuously supervised.

⚠ Never leave the appliance unattended during food drying. If the appliance is suitable for probe usage, only use a temperature probe recommended for this oven - risk of fire.

⚠ Keep clothes or other flammable materials away from the appliance, until all the components have cooled down completely - risk of fire. Always be vigilant when cooking foods rich in fat, oil or when adding alcoholic beverages - risk of fire. Use oven gloves to remove pans and accessories. At the end of cooking, open the door with caution, allowing hot air or steam to escape gradually before accessing the cavity - risk of burns. Do not obstruct hot air vents at the front of the oven - risk of fire.

⚠ Exercise caution when the oven door is in the open or down position, to avoid hitting the door.

PERMITTED USE

⚠ **CAUTION:** The appliance is not intended to be operated by means of an external switching device, such as a timer, or separate remote controlled system.

⚠ This appliance is intended to be used in household and similar applications such as: staff kitchen areas in shops, offices and other working environments; farm houses; by clients in hotels, motels, bed & breakfast and other residential environments.

⚠ No other use is permitted (e.g. heating rooms).

IMPORTANT TO BE READ AND OBSERVED

⚠ This appliance is not for professional use. Do not use the appliance outdoors.

⚠ Do not store explosive or flammable substances (e.g. gasoline or aerosol cans) inside or near the appliance - risk of fire.

INSTALLATION

⚠ The appliance must be handled and installed by two or more persons - risk of injury. Use protective gloves to unpack and install - risk of cuts.

⚠ Installation, including water supply (if any) and electrical connections, and repairs must be carried out by a qualified technician. Do not repair or replace any part of the appliance unless specifically stated in the user manual. Keep children away from the installation site. After unpacking the appliance, make sure that it has not been damaged during transport. In the event of problems, contact the dealer or your nearest After-sales Service. Once installed, packaging waste (plastic, styrofoam parts etc.) must be stored out of reach of children - risk of suffocation. The appliance must be disconnected from the power supply before any installation operation - risk of electrical shock. During installation, make sure the appliance does not damage the power cable - risk of fire or electrical shock. Only activate the appliance when the installation has been completed.

⚠ Carry out all cabinet cutting works before fitting the appliance in the furniture and remove all wood chips and sawdust. Do not obstruct the minimum gap between the worktop and the upper edge of the oven - risk of burns.

Do not remove the oven from its polystyrene foam base until the time of installation.

⚠ After installation, the bottom of the appliance must no longer be accessible - risk of burn.

⚠ Do not install the appliance behind a decorative door - risk of fire.

ELECTRICAL WARNINGS

⚠ The rating plate is on the front edge of the oven (visible when the door is open).

⚠ It must be possible to disconnect the appliance from the power supply by unplugging it if plug is accessible, or by a multi-pole switch installed upstream of the socket in accordance with the wiring rules and the appliance must be earthed in conformity with national electrical safety standards.

⚠ Do not use extension leads, multiple sockets or adapters. The electrical components must not be accessible to the user after installation. Do not use the appliance when you are wet or barefoot. Do not operate this appliance if it has a damaged power cable or plug, if it is not working properly, or if it has been damaged or dropped.

⚠ If the supply cord is damaged, it must be replaced with an identical one by the manufacturer, its service agent or similarly qualified persons in order to avoid a hazard - risk of electrical shock.

⚠ In case of replacement of power cable, contact an authorized service center.

CLEANING AND MAINTENANCE

⚠ **WARNING:** Ensure that the appliance is switched off and disconnected from the power supply before performing any maintenance operation; never use steam cleaning equipment - risk of electric shock.

⚠ Do not use harsh abrasive cleaners or metal scrapers to clean the door glass since they can scratch the surface, which may result in shattering of the glass.

⚠ Ensure the appliance is cooled down before any cleaning or maintenance. - risk of burn.

⚠ **WARNING:** Switch off the appliance before replacing the lamp - risk of electrical shock.

DISPOSAL OF PACKAGING MATERIALS

The packaging material is 100% recyclable and is marked with the recycle symbol . The various parts of the packaging must therefore be disposed of responsibly and in full compliance with local authority regulations governing waste disposal.

DISPOSAL OF HOUSEHOLD APPLIANCES

This appliance is manufactured with recyclable or reusable materials. Dispose of it in accordance with local waste disposal regulations. For further information on the treatment, recovery and recycling of household electrical appliances, contact your local authority, the collection service for household waste or the store where you purchased the appliance. This appliance is marked in compliance with European Directive 2012/19/EU, Waste Electrical and Electronic Equipment (WEEE). By ensuring this product is disposed of correctly, you will help prevent negative consequences for the environment and human health.

The  symbol on the product or on the accompanying documentation indicates that it should not be treated as domestic waste but must be taken to an appropriate collection center for the recycling of electrical and electronic equipment.

ENERGY SAVING TIPS

Only preheat the oven if specified in the cooking table or your recipe. Use dark lacquered or enamelled baking trays as they absorb heat better. Food requiring prolonged cooking will continue to cook even once the oven is switched off.

ECO DESIGN DECLARATION

This appliance meets the Eco Design requirements of European Regulations n.65/2014 and 66/2014 in conformity to the European standard EN 60350-1.

Installation

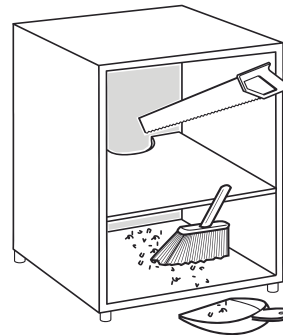
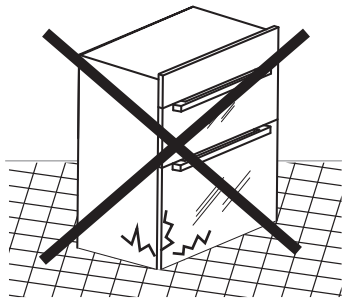
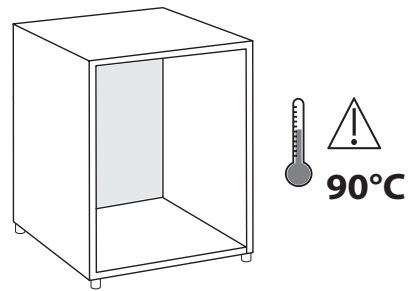
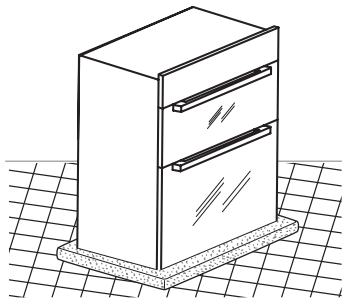
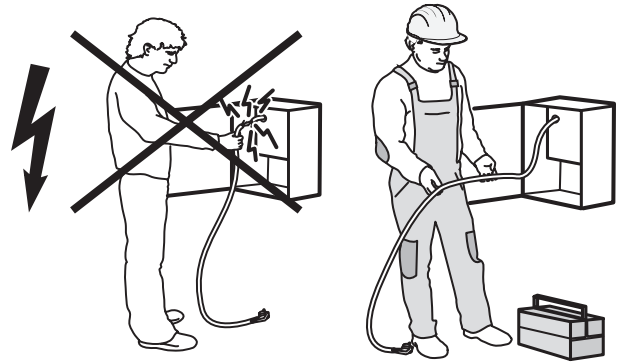
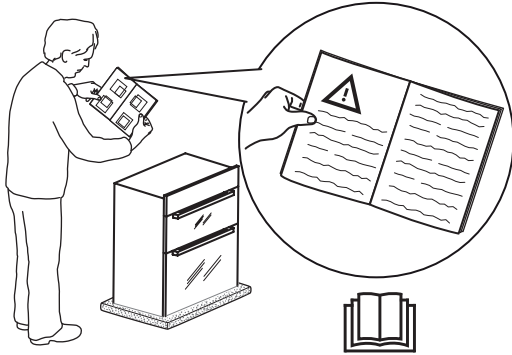
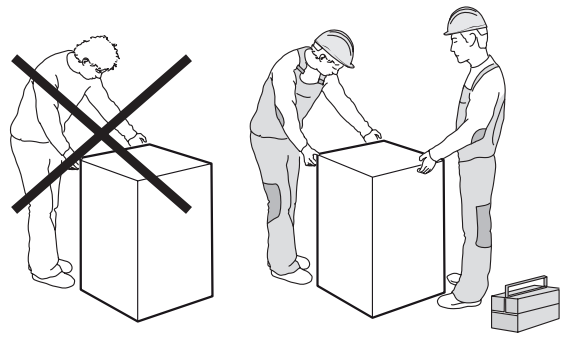
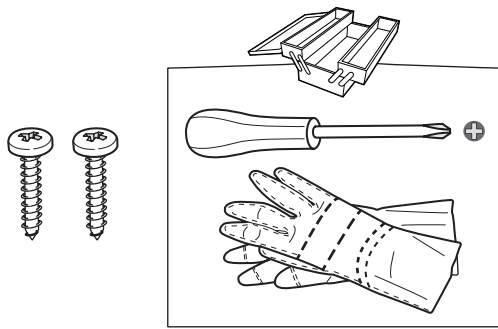

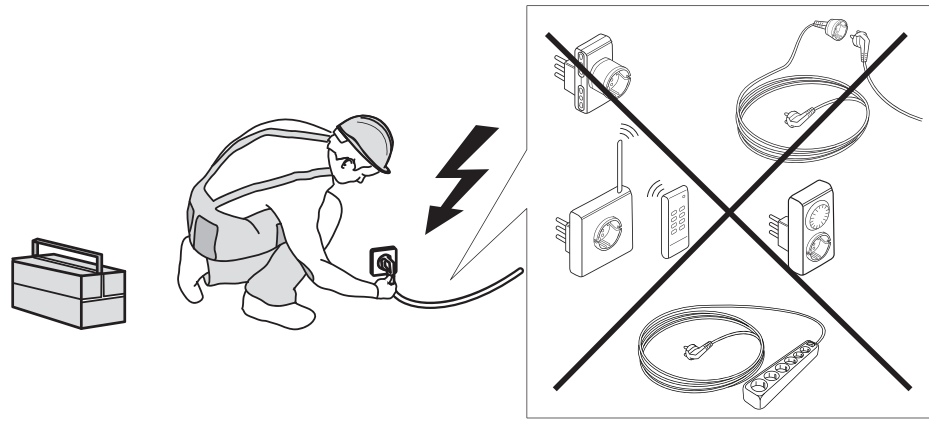
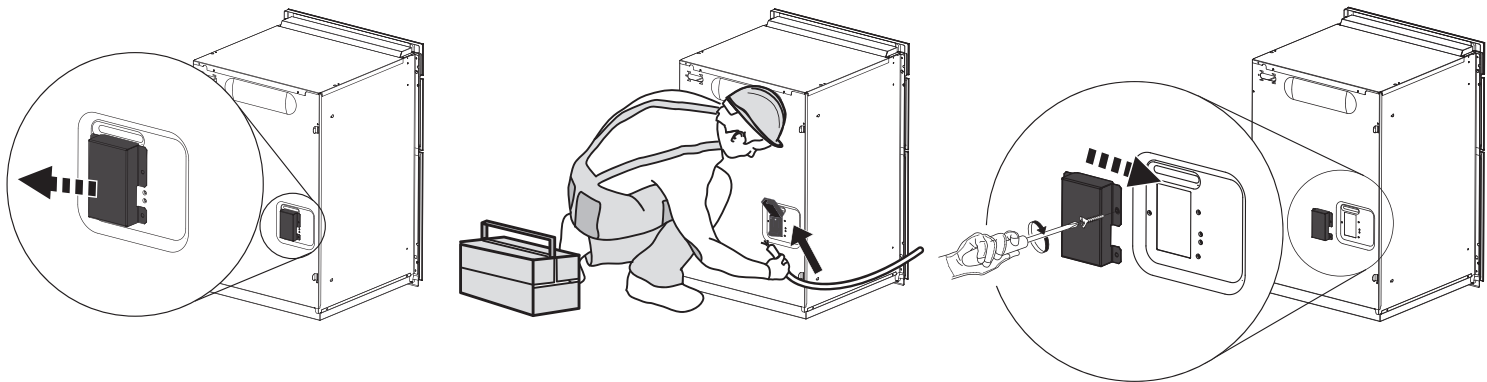
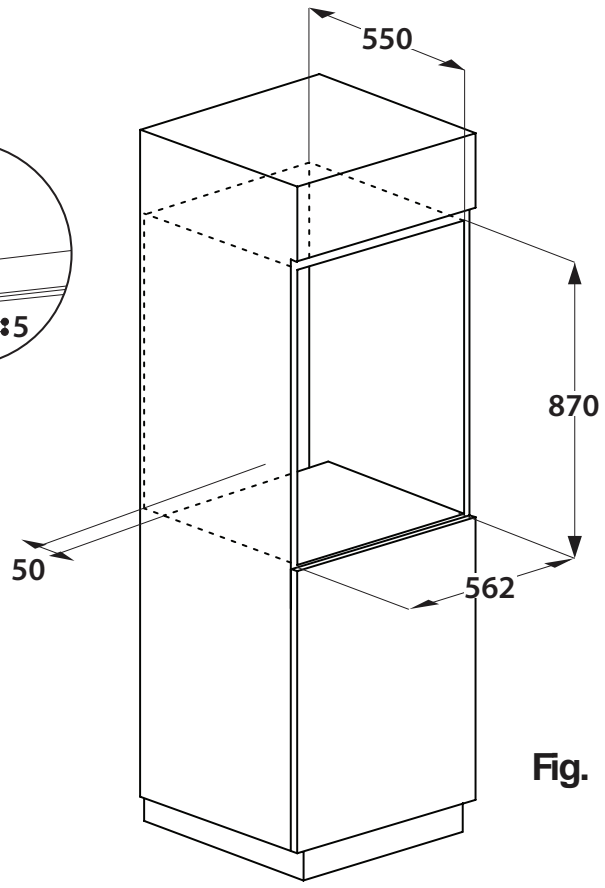
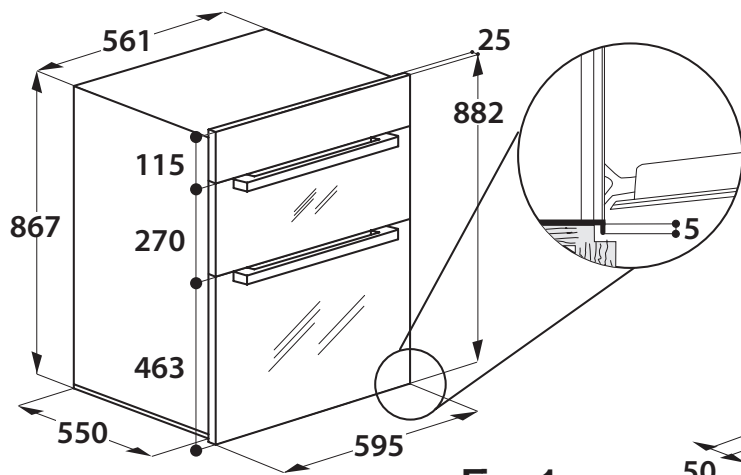

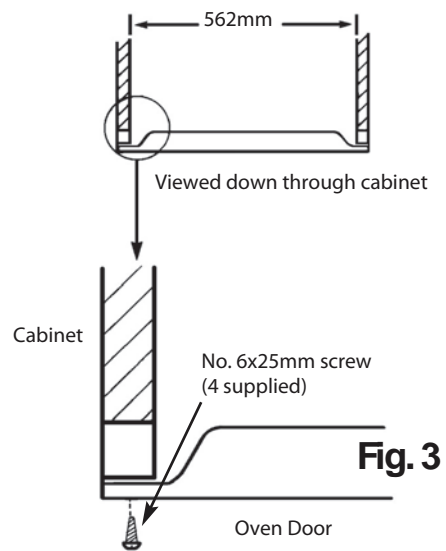
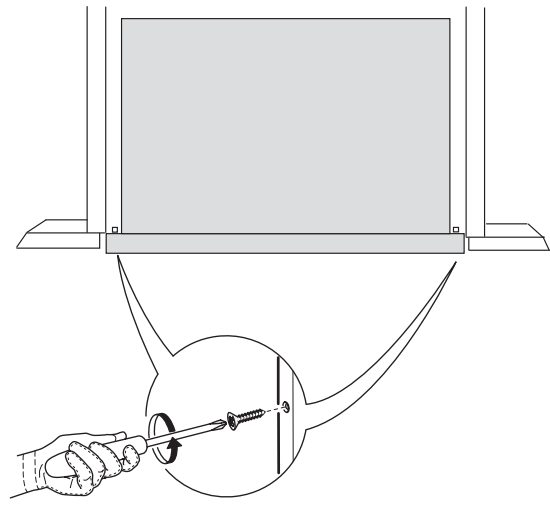
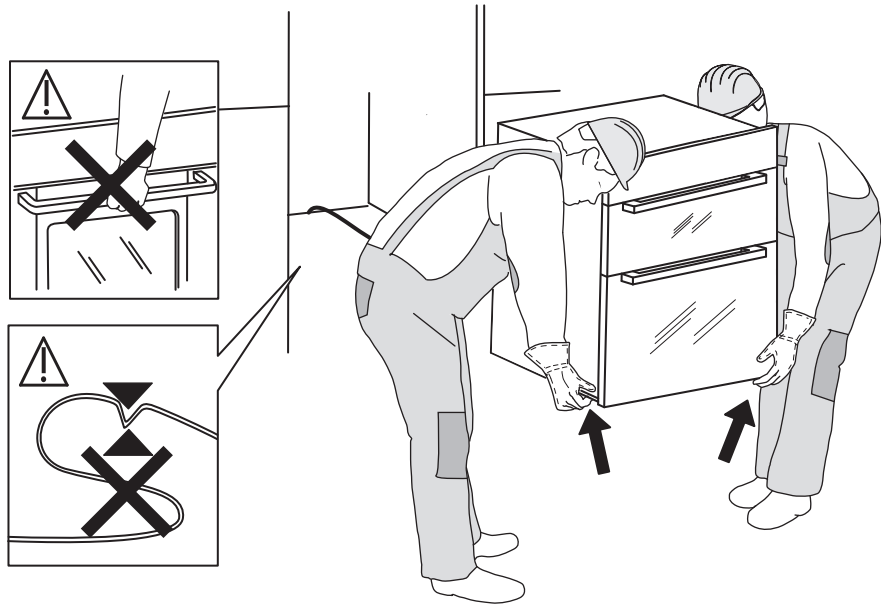
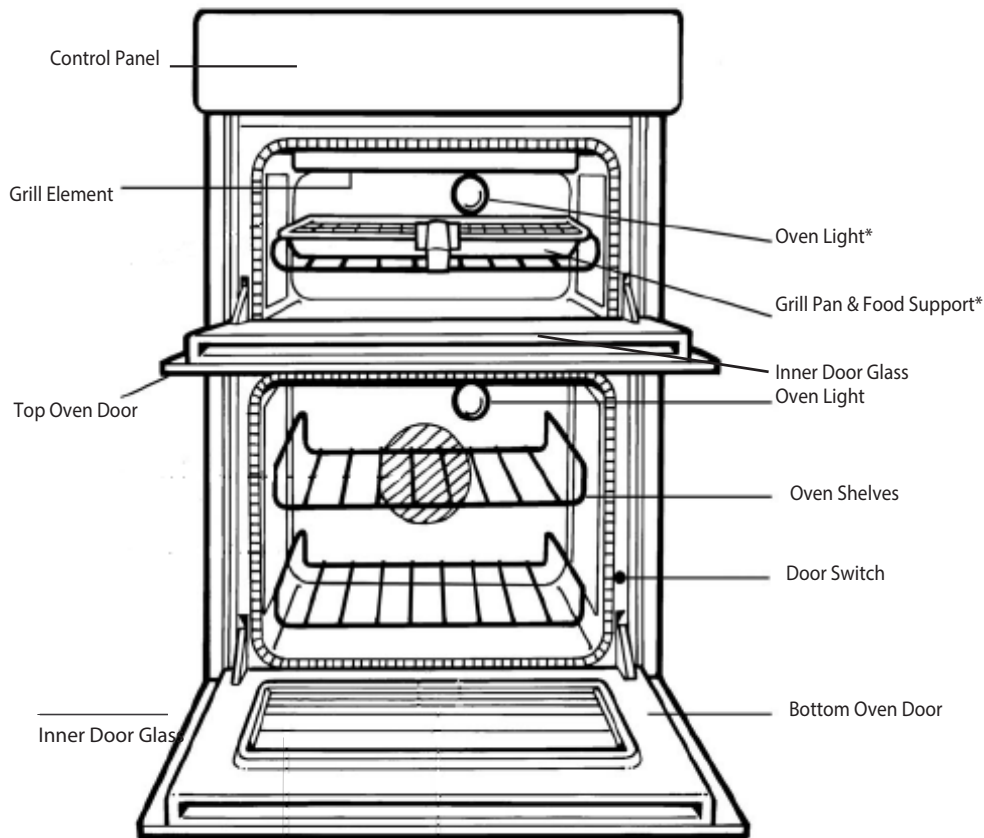

Fig. 3

The main parts of your Double Oven



* Only in some models

Telescopic runners *

The bottom oven on this cooker can come equipped with telescopic runners to facilitate inserting or removing accessories.

Assembling the telescopic runners*

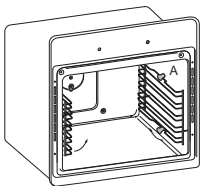

1. Remove the two frames, lifting them away from the spacers A (see figure).

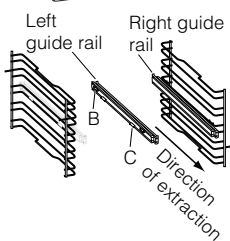

2. Choose which shelf to use with the sliding rack. Paying attention to the direction in which the sliding rack is to be extracted, position joint B and then joint C on the frame.

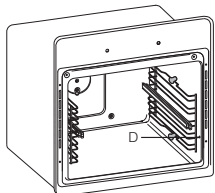

3. Secure the two frames with the guide rails using the holes provided on the oven walls (see diagram). The holes for the left frame are situated at the top, while the holes for the right frame are at the bottom.

4. Fit the frames on the spacers A.

4 KNOBS OVEN

(depending on which model is purchased)

CONTROLS

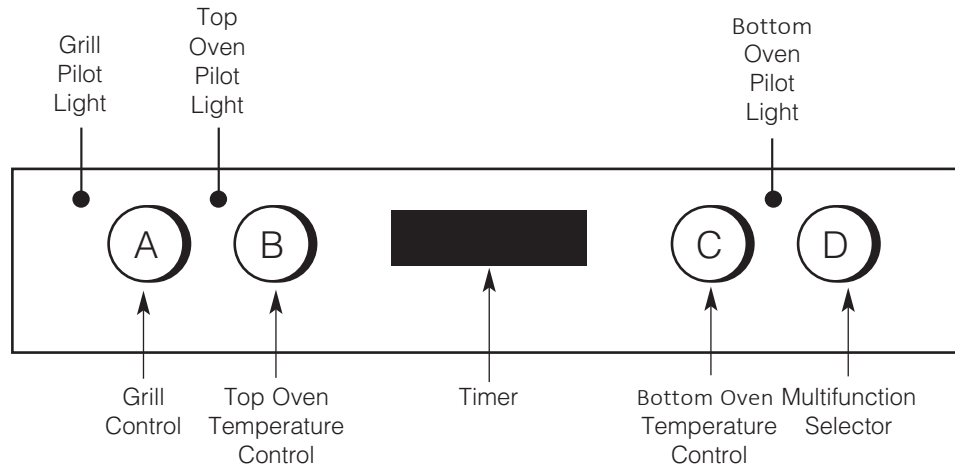

IMPORTANT

Before using your oven in the ordinary way, **ALWAYS** make sure that the timer has been set to **MANUAL** operation. Unless this is done, the bottom oven cannot heat up. Before seeking assistance, make sure this is done (refer to oven timer operation).

MULTIFUNCTION SELECTOR

Rotate the control knob in either direction to the required function. Many of the functions will also require the bottom oven thermostat to be set before the oven will heat up.

TOP OVEN TEMPERATURE CONTROL

Turn the control clockwise to set the top oven thermostat to the required temperature. An indicator light will illuminate. This will remain on until the oven reaches the required temperature. This light will then cycle on and off as the thermostat maintains control of the oven thermostat.

BOTTOM OVEN TEMPERATURE CONTROL

This is used in addition to the multifunction selector. This is used for the functions: fan oven, fan grill, half grill and full grill and conventional oven.

Turn the control clockwise to set the oven thermostat to the required temperature.

If the timer is set correctly and the selector switch set to a suitable function an indicator light will illuminate. This will remain on until the oven reaches the required temperature. This light will then cycle on and off as the thermostat maintains control of the oven temperature.

Slow Cooking

The bottom oven has a „Slow Cook Setting“ this can be used for slow cooking, keeping food warm and warming plates for a short period.

GRILL CONTROL

The grill control is designed to provide variable heat control of either both grill elements on together or the single left-hand grill element only.

To set the grill power turn the grill control to any setting MIN (1) - MAX (4), clockwise for FULL grill and anticlockwise for HALF grill.

Step 1 Ensure oven timer is set to manual. Place the shelf in the correct position (see Grilling Guide). Place the food/ grill pan on the shelf, positioned centrally under the grill element. Leave the top oven door fully open.

Step 2 Turn knob (A), clockwise for FULL grill or anticlockwise for HALF grill, to select the grill setting MIN (1) = Low, MAX (4) = High.

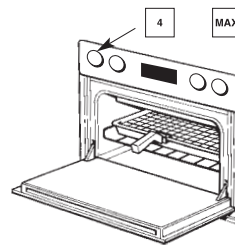

Grill Controls Example:

4 or MAX = High Grill Setting (depending on model)

NOTE: Do not grill with the grill/top oven door closed.

Step 3 After use, turn the grill control (A) to the off position (0).

The Grill Pilot Light is lit when grill is used. Ensure knob (B) is in „0 position“. The grill and the top oven cannot work simultaneously

COOLING FAN

A gentle flow of air will be blown below the control panel when the grill control is used and after a short period of time when the ovens are used.

Note: Whenever the appliance has been used, the cooling fan may run on or restart itself after all the controls have been turned off. This indicates that the appliance is still warm.

MULTIFUNCTION SELECTOR SWITCH

The Multifunction selector switch is used when operating the bottom oven.

With the exception of the O position the bottom oven light will remain on when this selector switch is used.

0 Off

With the selector in this position the bottom oven will not heat up. The timer will still operate.



Fan Oven

The oven fan and a rear element are controlled when this function is selected. Use the bottom oven thermostat control to set the required temperature.



Conventional Oven

Top and base elements are controlled when this function is selected. Use the bottom oven thermostat to set the required temperature.



Half Grill

With this function selected only the left hand side of the grill will be on. Use the oven thermostat control to set the required temperature.

Oven door must be open for grilling.



Full Grill

Both left and right hand grill elements will be on in this position. Use the oven thermostat control to set the required temperature.

Oven door must be open for grilling.



Fan Grill

The oven fan and fan grill element are controlled when this function is selected. Use the oven thermostat control to set the required temperature. Oven door must be closed for fan grilling.



Fan Only

The oven fan will operate when this function is selected. The oven thermostat control must be set in the off position.



Light Only

This function switches on the oven light only.

USING THE BOTTOM OVEN FOR OTHER FUNCTIONS

FAN ONLY SETTING

Defrosting frozen meat & Poultry

Joints of meat and whole birds should be defrosted slowly, preferably in a refrigerator (allowing 5-6 hours per lb.) or at room temperature (allowing 2-3 hours per lb.). Frozen meat or poultry must be completely defrosted before cooking in the oven. However, to decrease the amount of time required to defrost food items, a nonheating fan only setting may be selected for the bottom oven only.

Operation: To assist in defrosting

Place food in the oven and close the oven door. Turn the Multifunction Control (D) clockwise to the FAN ONLY setting.

Turn the bottom Oven Control (C) clockwise to the setting.

This defrosts by circulating the air around the food, time to defrost will depend on type and size of the food.

,S' SLOW COOK SETTING

This is used for slow cooking, keeping food warm and warming plates for short periods.

OPERATION:

1. Place the prepared food in the bottom oven and ensure the door is fully closed.
2. Select Slow Cooking Temperature, S' by turning the bottom Oven Temperature Control (C) and Multifunction Control (D) clockwise to Fan Oven mode.
3. Place the prepared food in the bottom oven and ensure the door is fully closed.
4. Select Slow Cooking Temperature, S' by turning bottom Oven Temperature Control (C).

LIGHT ONLY SETTING

When the Multifunction Control (D) is turned clockwise to the LIGHT ONLY setting, the bottom oven light only will illuminate. When the Bottom Oven Control (C) is turned clockwise to the setting, the bottom oven light only will illuminate.

3 KNOBS OVEN

(depending on which model is purchased)

CONTROLS

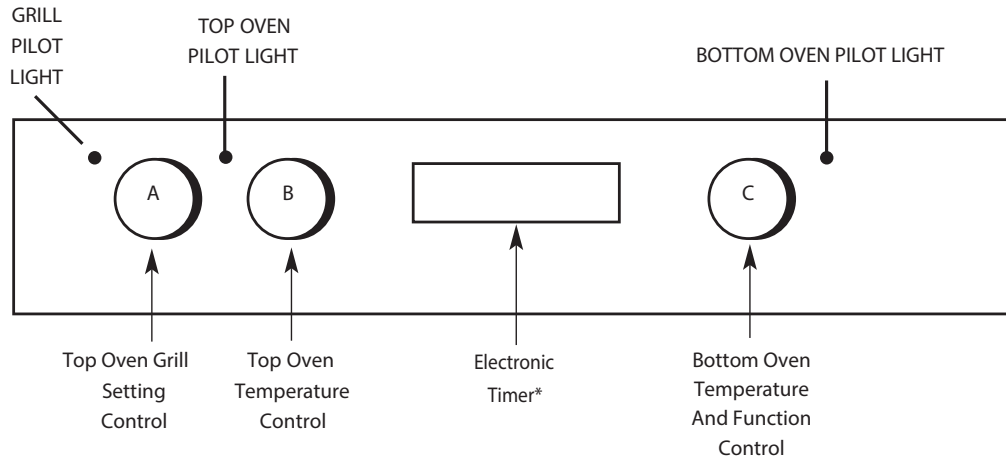

A - Grill Setting Control

Selects the heat at which the grill will cook the food.

Grill Settings Control: MIN - MAX

B - Top Oven Temperature Control

Selects the cooking temperature (Degrees Centigrade) when using the top oven as a conventional oven. 100 - MAX

C - Bottom Oven Temperature & Function Control

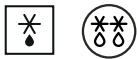

Fan Only Setting

This is used to decrease the amount of time required to defrost food items.



Oven Light Only

Switches on the Bottom Oven Interior Light Only Bottom Oven Temperature Scale (In Degrees Centigrade).

When cooking select the required cooking temperature.

Bottom Oven Temperature Scale (In Degrees Centigrade). 80 - MAX

When cooking select the required cooking temperature.

Cooling Fan

A gentle flow of air will be blown below the control panel when the grill control is used and after a short period of time when the ovens are used.

Note: Whenever the appliance has been used, the cooling fan may run on or restart itself after all the controls have been turned off. This indicates that the appliance is still warm.

Oven Interior Lights

The oven lights are operated when their respective oven control is used. The bottom oven has a light only position.

Slow Cooking

The bottom oven has a „Slow Cook Setting“ this can be used for slow cooking, keeping food warm and warming plates for a short period.

TOP OVEN GRILLING

Step 1 Ensure oven timer is set to manual. Place the shelf in the correct position (see Grilling Guide).

Step 2 Place the food/grill pan on the shelf, positioned centrally under the grill element. Leave the top oven door fully open. Turn knob (A), clockwise for FULL grill or anticlockwise for HALF grill, to select the Grill Setting (MIN-MAX).

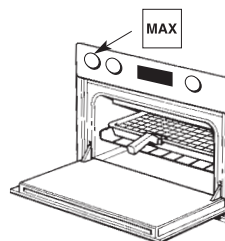

Grill Controls Example:

MAX = High Grill Setting (depending on model)

NOTE: Do not grill with the grill/top oven door closed.

Step 3 After use, turn the grill control (A) to the off position (0).

The Grill Pilot Light is on when grill is used. Ensure knob (B) is in „0 position“. The grill and the top oven cannot work simultaneously.

THE ELECTRONIC PROGRAMMER

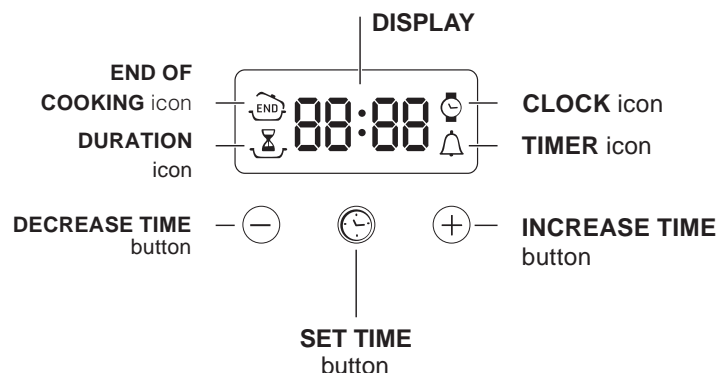



The Top Oven and Bottom Oven can be controlled by the automatic timer. When the timer control has been set for one oven, it is possible to use the other oven only during the same automatic cooking programme.

Setting the clock



The clock may be set when the oven is switched off or when it is switched on, provided that a the end time of a cooking cycle has not been programmed previously.

After the appliance has been connected to the mains, or after a blackout, the  icon and the four numerical digits on the DISPLAY will begin to flash.

1. Press the  button several times until the  icon and the four digits on the display begin to flash.
2. Use the "+" and "-" buttons to adjust the time; if you press and hold either button, the display will scroll through the values more quickly, making it quicker and easier to set the desired value.
3. Wait for 10 seconds or press the  button again to finalise the setting.



Setting the minute minder

This function does not interrupt cooking and does not affect the oven; it is simply used to activate the buzzer when the set amount of time has elapsed.

1. Press the  button several times until the  icon and the three digits on the display begin to flash.
2. Use the "+" and "-" buttons to set the desired time; if you press and hold either button, the display will scroll through the values more quickly, making it quicker and easier to set the value.
3. Wait for 10 seconds or press the  button again to finalize the setting. The display will then show the time as it counts down. When this period of time has elapsed the buzzer will be activated.

Programming cooking

A cooking mode must be selected before programming can take place.





1. Press the  button several times until the  icon and the three digits on the DISPLAY begin to flash.
2. Use the "+" and "-" buttons to set the desired duration; if you press and hold either button, the display will scroll through the values more quickly, making it quicker and easier to set the value.
3. Wait for 10 seconds or press the  button again to finalise the setting.

4. When the set time has elapsed, the text END appears on the DISPLAY, the oven will stop cooking and a buzzer sounds. Press any button to stop the buzzer and turn all control knobs to 0 position.

For example: it is 9:00 a.m. and a time of 1 hour and 15 minutes is programmed. The programme will stop automatically at 10:15 a.m.

Setting the end time for a cooking mode *

A cooking duration must be set before the cooking end time can be scheduled.

1. Follow steps 1 to 3 to set the duration as detailed above.
2. Next, press the  button until the  icon and the four digits on the DISPLAY begin to flash.
3. Use the "+" and "-" buttons to adjust the cooking end time; if you press and hold either button, the display will scroll through the values more quickly, making it quicker and easier to set the desired value.
4. Wait for 10 seconds or press the  button again to finalise the setting.
5. When the set time has elapsed, the text END appears on the DISPLAY, the oven will stop cooking and a buzzer sounds. Press any button to stop it. Programming has been set when the  and  buttons are illuminated.

The DISPLAY shows the cooking end time and the cooking duration alternately.

For example: It is 9:00 a.m. and a duration of 1 hour has been programmed. 12:30 is scheduled as the end time. The programme will start automatically at 11:30 a.m.

Cancelling a programme

1. Press the  button until the icon corresponding to the setting you wish to cancel and the digits on the display are flashing. Press the "-" button until the digits 00:00 appear on the display.
2. Press and hold the "+" and "-" buttons; this will cancel all the settings selected previously, including timer settings.

* By selecting the grill function, you will not be able to set an end time.

USING THE TOP OVEN FOR SOLARPLUS GRILLING

Solarplus high speed grill is designed to reduce your grilling times. It is quicker because it takes less time to warm up from cold. Conventional grills require 5 minutes pre-heat before food can be placed beneath them, but for

normal grilling the Solarplus grill can be used directly from cold without any pre-heat.

However, when toasting, optimum performance is achieved by pre-heating the grill for about 1 minute.

GRILL PAN AND HANDLE

The grill pan handle is detachable from the pan to facilitate cleaning and storage.

Fix the pan handle securely before use:

Fit the handle to the grill pan so that the external 'hooks' embrace the edge of the pan (fig. 1)

Make sure that the middle part of the handle fits exactly the protruding support of the pan (fig. 2) and holds the pan from the bottom.

The food must be placed on the rack in the grill pan. Position the grill pan on top of the oven rack. The best results are achieved by placing the oven rack on the uppermost shelves. Pouring a little drinking water into the grill pan will make the collection of grease particles more efficient and prevent the formation of smoke.

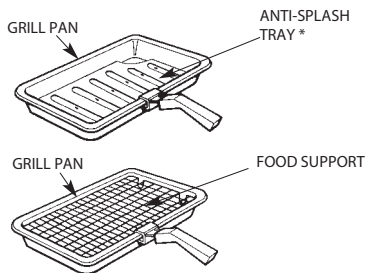
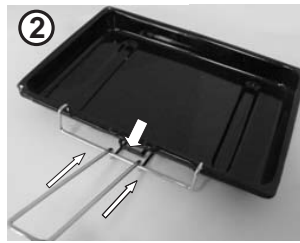
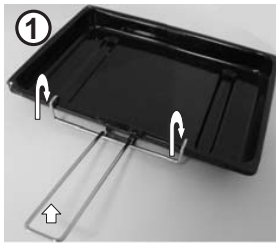

Note: To stop fat splashing onto the grill mesh, it is important to use the anti-splash tray as shown in the grilling chart. Always clean the grill pan, anti-splash tray* and food support after each use.

Top Oven Shelf Positioning for Grilling

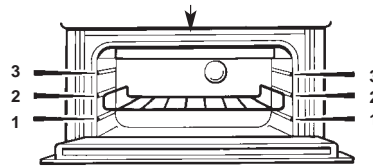

NOTE:

- Preheat the grill if indicated on grill chart.
- The grill pan must be placed on the correct shelf and positioned centrally under the grill element.

- Leave the control at MAX for toast, and for fast cooking of foods.
- For thicker foods requiring longer cooking, turn the switch to a lower setting after the initial sealing on both sides at MAX. The thicker the food, the lower the control should be set.
- After use always return the grill control to the OFF (1) position.

* Only in some models

USING THE TOP OVEN AS A CONVENTIONAL OVEN

The top oven should be used to cook small quantities of food. The oven is designed so that the grill element operates at a reduced heat output, this is combined with a heating element situated underneath the floor of the oven. To ensure even cooking of the food it is important that cooking utensils are positioned correctly on the oven shelf so that the element is directly above. As a guide, the front of the utensil should be approx. 100mm (4") from the front of the shelf.

SHELF POSITIONING

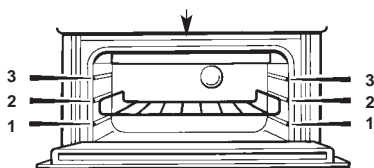

There should always be at least 25mm (1 inch) between the top of the food and the grill element.

Operation when using the Top Oven as a Conventional Oven

Step 1 Check that the timer is in manual.

Step 2 Place the shelf in the correct position (see Oven Temperature Charts).

Step 3 Select the required cooking temperature (100 °C MAX) using control (B) (see Top Oven Temperature Charts). The pilot light will immediately come on, and remain on until the oven reaches the required temperature. The light will then automatically go off and on during cooking as the oven thermostat maintains the correct temperature.

Step 4 Place the food on the shelf directly below the element ensuring the oven door is closed.

NOTE: At the end of your cooking, always return control (B) to the OFF (O) position.

PLATE WARMING

Place the plates/dishes on shelf position 1 from the base of the top oven, and turn top oven temperature control (B) to 100°C for 10-15 minutes.

BOTTOM OVEN - FAN GRILLING

(Only in 4 knobs models)

Fan grilling is a combination of heat from the grill element and the oven fan circulating the hot air around the food. Joints of meat and poultry will be browned as if they were cooked on a rotisserie or spit but more economically as the door left closed.

If required, fan grilling can be timed using the Oven Auto timer.

Follow the timer instructions before selecting fan grill and the required temperature.

If Manual fan grilling is required always ensure the timer is set to Manual.

Operating Instruction

1. Open the oven door.
2. Select the correct shelf position, as stated in chart.
3. Turn the selector switch to the Fan grill position.
4. Turn the oven thermostat control to the required temperature (see Fan Grilling Roasting Chart).
5. Position the meat pan centrally under the grill elements.
6. Close the oven door.
7. After use always return both controls to the off position.
8. If the oven timer was used, reset to Manual. As with the fan oven cooking there is no need to preheat the oven yet another economy feature. Also you can cook more than one thing at a time even up to 4 small chickens.

Temperatures

These will be similar to those used for the more traditional form of roasting but the guide will give you an indication of which temperature to set the Thermostat.

But remember that because of the way the oven is heated

this is a more economical way of roasting.

General Recommendations

Most types of meat and poultry cooked by this method will have an all over brownness and crispness on the outside. The only exceptions are very lean joints, such as veal, which, because of its low fat content, is better cooked using conventional heating.

1. Always place the pan on the shelf position recommended. (See Chart).
2. There is no need to preheat the oven before cooking and all fan grilling should be carried out with the oven door closed, this saves energy. The cooking temperatures and times are calculated from a cold oven.
3. After rinsing and drying meat, place on the food roasting support rack over the pan supplied.
4. Position meat in oven as recommended in the roasting chart.
5. Fan grilling is ideally suited for cooking all types of poultry and larger joints of meat (e.g. stuffed, rolled joints and legs of pork and lamb). Results will be as if you had cooked the food on a rotisserie. If you use frozen meat or poultry it must be completely defrosted before it is cooked.
6. When cooking a joint always grill it with the fat side uppermost in order to crisp it. For bigger joints or where there is little bone, grill at the lower temperature given in the table and cook for a longer time per kg.
7. When cooking any type of poultry, start grilling the underside uppermost and turn breast uppermost about a third to halfway through the cooking period. If cooking stuffed poultry allow slightly longer cooking time.

BOTTOM OVEN - CONVENTIONAL OVEN

(Only in 4 knobs models)

Operating Procedure

1. Ensure Oven Timer is set to Manual.
2. Position rod shelf as recommended in the chart for food being cooked.
3. Position food centrally under grill element.
4. Turn the selector switch to the conventional oven position.
5. Turn the oven thermostat control to the required temperature setting (see oven temperature charts). The oven light will remain on. The oven indicator light will remain on until the oven reaches the set temperature. This light will then automatically cycle on and off during cooking as the oven temperature is controlled.
6. After use always return both controls to the off position and close the oven door.

BOTTOM OVEN - FAN OVEN

Important: The oven is heated by elements at the rear of the oven. A fan at the rear of the oven operates to circulate heated air within the oven.

Operating procedure:

1. Ensure Oven Timer is set to Manual.
2. Turn the selector switch to the fan oven position, then turn the oven thermostat control to the required temperature setting (see oven temperature charts).

BOTTOM OVEN - FAN OVEN COOKERY NOTES

Since a fan oven heats up more quickly, and generally cooks food at a lower temperature than a conventional oven, pre-heating the oven is often unnecessary. However, foods such as bread, scones, Yorkshire pudding, do benefit from being placed in a pre-heated oven.

The charts are a guide only, giving approximate cooking temperatures and times. To suit personal taste and requirements, it may be necessary to increase or decrease temperatures by 10°C.

Because the fan oven cooks so efficiently, we recommend that when cooking any recipes not designed for a fan oven, you reduce the temperature by about 25°C and the time by about 10 minutes in the hour. If large quantities are being cooked it will be necessary to increase the cooking time somewhat to compensate for the extra oven load.

Unless otherwise indicated in the charts, food is placed in a cold oven, i.e. without preheating.

If food is placed in an already hot oven, the suggested cooking time should be reduced, depending on the type and quantity of food being cooked.

It should be noted that at the end of a cooking period there may be a momentary puff of steam when the oven door is opened, this will disperse in a few seconds and is a perfectly normal characteristic of an oven with a good door seal.

3. The oven light will remain on. The oven indicator light will remain on until the oven reaches the set temperature. This light will then automatically cycle on and off during cooking as the oven temperature is controlled.

4. After use always return all controls to the off position and close the oven door.

Oven Positions

Since the distribution of heat in the fan oven is very even, most foods will cook satisfactorily on any shelf position, but the shelves should be evenly spaced:

To ensure even circulation do not use meat pans larger than 390x300mm (15ins x 12ins) and baking trays no larger than 330x255mm (13ins x 10ins), these should be positioned centrally on the oven shelf.

Do not fit shelves upside down.

Never use more than 3 shelves in the oven as air circulation will be restricted.

Food or cooking utensils should not be placed on the floor of the oven. To avoid unnecessary cleaning, rod shelves which are not in use should be removed from the oven.

Temperature and Time

The oven is provided with two shelves. A third is available as an optional extra, contact Genuine Parts and Accessories Hotline (see back page) for further information.

If three shelves are used to cook large quantities of food for home freezing or parties, it may be necessary to increase the cooking times given in the charts by a few minutes, to allow for the loss of heat due to the extra time taken to load the oven, and the larger mass of food.

Baking trays should allow an equal gap on all sides of the oven.

To prepare meat and poultry for Roasting in your Fan Oven

(a) Wipe the meat or poultry, dry well and weigh it. Meat which has for been stored in a refrigerator should be allowed to come to room temperature before cooking, and frozen meat or poultry must be completely defrosted before placing in the oven. (b) The weight of any stuffing used should be added before calculating the cooking time. (c) Place meat/poultry in the bottom oven meat pan supplied with your cooker. Small joints weighing less than 1.75kg (3 1/2 lbs) should be roasted in a smaller meat pan/tin or they may be, 'pot roasted' a small joint or a large meat pan causes unnecessary oven splashing and evaporation of meat juices.

(d) Additional fat should not be added, except for veal, very lean meat or poultry which can either be 'larded' with fat bacon or brushed very sparingly with cooking oil or melted fat.

(e) Beef, lamb, mutton and poultry may be dusted lightly with seasoned flour to give a crisp outer surface. The skin of duck and goose should be pricked to release excess fat during cooking, and the rind of pork should be scored, brushed lightly with oil, and rubbed with salt to give crisp crackling.

(f) Meat and poultry wrapped in, or covered with a tent of aluminium foil will be juicy and tender. Roasting bags offer the same advantages. Always follow the manufacturer's pack instructions, and remember to reduce the temperatures given for conventional ovens by approximately 25°C and the time by approximately 10 minutes per hour.

(g) Potatoes for roasting only require to be brushed with cooking oil or melted fat.

(h) It is not necessary to baste when roasting in an electric oven and stock or liquid should not be added to the meat pan since this only causes unnecessary soiling, steam and condensation.

Frozen Meat and Poultry

Joints of meat and whole birds should be defrosted slowly, preferably in a domestic refrigerator (allowing 5-6 hours per 450g, 1 lb), or at room temperature (allowing 2-3 hours per 450g, 1 lb).

Frozen meat or poultry must be completely defrosted before placing in the oven.

It is essential to wash thoroughly and cook meat and poultry immediately after defrosting.

BOTTOM OVEN GRILLING (Only in 4 knobs models)

GRILLING SHOULD NEVER BE UNDERTAKEN WITH THE DOOR CLOSED.

- Do Not line the grill pan with aluminium foil.
- Ensure that the grill pan is cleaned after every use. Excess fat build-up in the bottom of the pan could cause a fire hazard.
- Preheat the grill on the required setting for 5 minutes

Grilling Procedure:

1. Open the bottom oven door fully and position the rod shelf as recommended in the grilling chart for the food being cooked.
2. Turn the multifunction selector switch to HALF grill or FULL grill and then turn the bottom Oven temperature control to the required setting to pre-heat for approximately 5 minutes.

3. Position the grill pan centrally under the grill element and push back as far as the location stops on the rod shelf.

4. Leave the oven thermostat at setting MAX for toast and for fast cooking of foods. For thicker foods requiring longer cooking turn the thermostat to a lower setting, after initial sealing on both sides at MAX. The thicker the food, the lower the thermostat should be set. If excessive smoke is emitted, reduce the setting.

5. After use always return both controls to their OFF (O) position.

Grilling in top oven

FOOD	PREHEAT FOR 5 MINUTES (depending on Model)	SHELF POSITION FROM THE BASE OF THE OVEN	SETTING (depending on Model)	APPROXIMATE COOKING TIME	PAN TO BE USED
Toasting of Bread Products	Setting MAX	3 or 2	Setting 4 or MAX	5 - 10 minutes	Grill pan and food support
Small cuts of meat, Sausage, Bacon	Setting MAX	3 or 2	Setting 4 or MAX for 4 minutes then reduce to LOWER setting	10 - 25 minutes	Grill pan and food support *
Chops etc. Gammon steaks	Setting MAX	2	Setting 4 or MAX for 6-8 minutes then reduce to LOWER setting	20 - 35 minutes	Grill pan and food support *
Fish: Whole Fillets Fingers	Setting MAX	2 3 3	Setting 4 or MAX	8 - 12 minutes 10 - 15 minutes 10 - 20 minutes	Grill pan and food support *
Pre-cooked potato products	Setting MAX	3 or 2	Setting 3 or lower setting	15 - 20 minutes	Grill pan and food support
Browning of food eg. Cauliflower Cheese	Setting MAX	3 or 2	Setting 4 or MAX	10 - 20 minutes	Dish placed directly on the shelf

* We recommend using the pan to collect the cooking juices: Position it below the food support and add 500 ml of drinking water.

Grilling in bottom oven

(Only in 4 knobs models)

Food	Shelf Position from base of oven	Setting Required Temp °C	Cooking Time
Toasting of bread products	5	MAX	2-5 mins
Small cuts of meat, sausages, bacon etc.	4 or 5	MAX for 4- 6 mins then reduce to setting 170	10-20 mins
Chips, gammon steaks etc.	5	MAX for 4- 6 mins then reduce to setting 170	20-30 mins
Fish: Whole / Fillets	4	170	15-20 mins
Fish Fingers	5	MAX	10-15 mins
Browning of food	5	MAX	5-10 mins

Top Oven Temperature Charts

Baking

Top Oven - Conventional Cooking

Baking	Pre-heat	Temperature °C	Time in mins.	Position in Oven
Scones	Yes	210/220	10-15	Runner 2 from bottom of oven
Small Cakes	Yes	170/180	20-30	Runner 2 from bottom of oven
Victoria Sandwich	Yes	170/180	20-30	Runner 2 from bottom of oven
Sponge Sandwich (fatless)	Yes	180/190	20-25	Runner 2 from bottom of oven
Swiss Roll	Yes	200/210	10-15	Runner 2 from bottom of oven
Semi-rich Fruit cakes	Yes	150/160	60-75	Runner 2 from bottom of oven
Rich Fruit Cakes	Yes	140/150	Time Dependent on size	Runner 1 or 2 from bottom of oven
Shortcrust Pastry	Yes	170/180	Time Dependent on recipe	Runner 2 from bottom of oven
Puff Pastry	Yes	200/210	Time Dependent on recipe	Runner 1 from bottom of oven
Yorkshire Pudding	Yes	190/200	30-40	Runner 1 or 2 from bottom of oven
Individual Yorkshire Pudding	Yes	200/210	20-30	Runner 1 from bottom of oven
Milk Pudding	Yes	140/150	90-120	Runner 1 from bottom of oven
Baked Custard	Yes	150/160	40-50	Runner 1 from bottom of oven
Bread	Yes	200/210	30-45	Runner 1 from bottom of oven
Meringues	Yes	100	150-180	Runner 2 from bottom of oven

Bottom oven - Fan Cooking

Baking	Pre-heat	Temperature °C	Time in mins.
Scones	Yes	210/220	9-12
Small Cakes	No	170/180	15-20
Victoria Sandwich	No	160/170	20-25
Sponge Sandwich (fatless)	Yes	190/200	15-20
Swiss Roll	Yes	190/200	10-15
Semi-rich Fruit cakes	No	140/150	1¼ - 1½ hrs
Rich Fruit Cakes	No	130/140	Depending on size
Shortcrust Pastry	No	190/200	Depending on size
Puff Pastry	No	190/200	Depending on size
Yorkshire Pudding	Yes	180/190	40-45
Individual Yorkshire Pudding	Yes	190/200	20-25
Milk Pudding	No	130/140	1½ - 2 hrs
Baked Custard	No	140/150	35-45
Bread	Yes	200/210	30-35
Meringues	No	80/90	3 - 4 hrs

Top Oven Temperature Charts

Meat

Top Oven - Conventional Cooking

Meat	Pre-heat	Temperature °C	Time (approx.)	Position in Oven
Beef/ Lamb (slow roasting)	Yes	170/180	35 mins per 450g (1lb) + 35 mins over.	Runner 2 from bottom of oven.
Beef/ Lamb (foil covered)	Yes	190/200	35-40 mins per 450g (1lb)	
Pork (slow roasting)	Yes	170/180	40 mins per 450g (1lb) + 40 mins over	
Pork (foil covered)	Yes	190/200	40 mins per 450g (1lb)	
Veal (slow roasting)	Yes	170/180	40-45 mins per 450g (1lb) + 40 mins over	
Veal (foil covered)	Yes	190/200	40-45 mins per 450g (1lb)	
Poultry/Game (slow roasting)	Yes	170/180	25-30 mins per 450g (1lb) + 25 mins over	
Poultry/Game (foil covered)	Yes	190/200	25-30 mins per 450g (1lb)	
Casserole Cooking	Yes	150	2-2½ hrs	

Bottom oven - Fan Cooking

Meat	Pre-heat	Temperature °C	Time (approx.)	Position in Oven
Beef	No	160/180	20-25 mins per 450g (1lb) + 20 mins extra.	Runner 2 from bottom of oven.
Lamb	No	160/180	20-30 mins per 450g (1lb) +25 mins extra.	
Pork	No	160/180	25-30 mins per 450g (1lb) +25 mins extra.	
Veal	No	160/170	25-30 mins per 450g (1lb) +25 mins extra.	
Chicken/Turkey up to 4kg (8lb)	No	160/180	18-20 mins per 450g (1lb) + 20 mins extra.	
Turkey 4 to 5.5kg (8 to 12lb)	No	150/160	13-15 mins per 450g (1lb) at 150/160°C	
Turkey 4 to 5.5kg (8 to 12lb)		150	allow 12 mins per 450g (1lb) at 150°C	
Casserole Cooking	No	140-150	1½ - 2 hrs	

The most accurate method of testing the readiness of joints of meat or whole poultry is to insert a meat thermometer into the thickest part of a joint, or the thickest part of poultry thighs, during the cooking period. The meat thermometer will indicate when the required internal temp has been reached.

Beef - Rare: 60°C **Lamb:** 80°C **Poultry:**90°C
 Medium: 70°C **Pork:** 90°C
 Well Done: 75°C **Veal:** 75°C

Bottom Oven Roasting Chart

Fan Grilling

(Only in 4 knobs models)

Shelf positions are counted from the base upwards ie: lowest shelf position is 1.

Type of Meat or Poultry	Weight kg	Temp °C	Time (min/kg)	Plus Extra Time (mins)	Total Cooking Time (mins)	Tips
PORK						
Pork Chop - thick		170	25		Dependente on size	Season. Grill on shelf position 3. Turn over after 15 mins. Grill on shelf position 3 Turn after 15 mins. Score fat with sharp knife and rub on salt. Pork should always be thoroughly cooked. So overcook rather than undercook. Grill on shelf position 1.
Gammon Steaks Pork -		160	30		Dependente on size	
any type of joint	1.0	160-170	60-70	45	105-120	
	1.5	150-170	60-70	45	130-150	
	2.0	140-150	65-75	50	180-230	
	2.5	140-150	65-75	50	220-240	
	over 2.5	140	70-75	50	-	
LAMB						
Lamb chop - thick		170	25		Dependent on size	Season. Grill on shelf position 3. Turn over after 15 mins. Score fat. Season with pepper and rosemary. If you prefer the lamb pink choose the shorter time Grill on shelf position 1.
Lamb - any type of joint	1.0	160-170	30-40	45	78-88	
	1.5	160-170	35-40	45	90-110	
	2.0	150-160	35-45	50	120-140	
	2.5	150-160	40-45	50	150-170	
	Over 2.5	150	45-50	50	-	
BEEF						
Beef - joints which have an outside layer of fat eg. Rib, Rolled, Sirloin	1.0	170-180	40-50	20	60-70	Season. If joint preferred rare grill for the shorter time. If preferred well done grill for the longer time. Grill on shelf position 1.
	1.5	170-180	40-50	20	80-90	
	2.0	160-170	40-50	20	100-110	
	2.5	160-170	45-50	30	140-150	
	over 2.5	160	45-50	40	-	
CHICKEN						
	1.0	180	30	30	60	Season and brush over with melted butter to give nicely browned skin. Grill on shelf position 1. Shelf 1.
	1.5	180	30	30	75	
	2.0	170	35	30	100	
	2.5	170	35	30	115	
	over 2.5	160-170	40	30	-	
Chicken joints	less than 1kg each	180	30	30	60	
DUCK						
	1.5	180	30	30	75	Dry thoroughly and lightly salt. Grill on shelf position 1.
	2.0	180	30	30	90	
	2.5	180	35	30	115-130	
GOOSE						
	up to 4	170-190	40	40	-	Can be stuffed. Grill on shelf position 1
	4-5	160-170	45	40	-	
TURKEY						
	up to 5	170	-	-	150-165	Season and brush over with melted butter to give nicely browned skin. Grill on shelf position 1.
	6-8	150	-	-	165-175	
GAME						
Grouse	Any	170-180	30-50	-	-	Well hung meat will require less cooking time. grill on position 1.
Partridge	Any	170-180	40-50	-	-	
Pheasant	Any	170-180	40-50	-	-	
Beefburgers	450g(lb)	170	25mins per 450g (lb)			Shelf 3. Shelf 3. Prick sausages before cooking. Shelf 3. Roll up bacon before cooking. 4 pieces of steak, sausages, chops, bacon, tomatoes & mushrooms. Cook sausages, chops, bacon for 10 mins. add steak, cook for further 20 mins.
Sausages	450g(lb)	170	25mins per 450g (lb)			
Bacon	450g(lb)	170	25mins per 450g (lb)			
Mixed Grill		170			30	

Bottom Oven Temperature Chart Meat

(Only in 4 knobs models)

Conventional Oven

Meat	Pre-heat	Temperature °C	Time (approx.)	Position in Oven
Beef/ Lamb (slow roasting)	Yes	170/180	35 mins per 450g (1lb) + 35 mins over.	Runner 2 from bottom of oven.
Beef/ Lamb (foil covered)	Yes	190/200	35-45 mins per 450g (1lb)	
Pork (slow roasting)	Yes	170/180	40 mins per 450g (1lb) + 40 mins over	
Pork (foil covered)	Yes	190/200	40 mins per 450g (1lb)	
Veal (slow roasting)	Yes	170/180	40-45 mins per 450g (1lb) + 40 mins over	
Veal (foil covered)	Yes	190/200	40-45 mins per 450g (1lb)	
Poultry/Game (slow roasting)	Yes	170/180	25-30 mins per 450g (1lb) + 25 mins over	
Poultry/Game (foil covered)	Yes	190/200	25-30 mins per 450g (1lb)	
Casserole Cooking	Yes	150	2-2½ hrs	

Fan Oven

Meat	Pre-heat	Temperature °C	Time (approx.)
Beef	No	160/180	20-25 mins per 450g (1lb) + 20 mins extra.
Lamb	No	160/180	20-30 mins per 450g (1lb) +25 mins extra.
Pork	No	160/180	25-30 mins per 450g (1lb) +25 mins extra.
Veal	No	160/170	25-30 mins per 450g (1lb) +25 mins extra.
Chicken/Turkey up to 4kg (8lb)	No	160/180	18-20 mins per 450g (1lb) + 20 mins extra.
Turkey 4 to 5.5kg (8 to 12lb)	No	150/160 or 150	12-14 mins per 450g (1lb) at plus 12 mins extra *For every 450g (1lb) over 5.5kg (12lb) allow 10 mins per 450g (1lb) and roast at 150°C
Casserole Cooking	No	140-150	1½ - 2 hrs

The most accurate method of testing the readiness of joints of meat or whole poultry is to insert a meat thermometer into the thickest part of a joint, or the thickest part of poultry thighs, during the cooking period. The meat thermometer will indicate when the required internal temp has been reached.

Beef - Rare: 60°C **Lamb:** 80°C **Poultry:** 90°C
Medium: 70°C **Pork:** 90°C
Well Done: 75°C **Veal:** 75°C

Bottom Oven Temperature Chart Baking

(Only in 4 knobs models)

Baking		Conventional Oven		
Food	Pre-heat	Temperature °C	Time in mins.	Shelf Position
Scones	Yes	220/230	10-15	2nd from bottom
Small Cakes	Yes	180/190	15-25	3rd from bottom
Victoria Sandwich	Yes	160/170	20-30	3rd from bottom
Sponge Sandwich (fatless)	Yes	170/180	15-20	3rd from bottom
Swiss Roll	Yes	190/200	8-12	3rd from bottom
Semi-rich Fruit cakes	Yes	150/160	1¼ hrs. 7"	2nd from bottom
Rich Fruit Cakes	Yes	130/140	Depending on recipe and size	2nd from bottom
Shortcrust Pastry	Yes	180/190	Depending on use	2nd or 3rd from bottom
Puff Pastry	Yes	190/200	Depending on use	2nd or 3rd from bottom
Yorkshire Pudding	Yes	190/200	40-45	3rd from bottom
Individual Yorkshire Pudding	Yes	200/210	20-30	3rd from bottom
Milk Pudding	Yes	140/150	1¼ - 2 hrs.	2nd from bottom
Baked Custard	Yes	130/140	40-50	3rd from bottom
Bread	Yes	190/200	25-35	3rd from bottom
Meringues	Yes	80/90	3 - 3½ hrs.	3rd from bottom

Baking	Fan Oven		
Food	Pre-heat	Temperature °C	Time in mins.
Scones	Yes	210/220	9-12 approx.
Small Cakes	No	170/180	15-25 approx.
Victoria Sandwich	No	160/170	20-30 approx.
Sponge Sandwich (fatless)	Yes	180/190	15-20 approx.
Swiss Roll	Yes	190/200	12-15 approx.
Semi-rich Fruit cakes	No	140/150	1¼ - ½ hrs. approx.
Rich Fruit Cakes	No	130/140	Depending on size
Shortcrust Pastry	No	190/200	Depending on size
Puff Pastry	No	190/200	Depending on size
Yorkshire Pudding	Yes	180/190	40-50 approx.
Individual Yorkshire Pudding	Yes	190/200	20-25 approx.
Milk Pudding	No	130/140	1½ - 2 hrs. approx.
Baked Custard	No	140/150	35-45 approx.
Bread	Yes	200/210	30-35 approx.
Meringues	No	80/90	3 - 4 hrs. approx.

Care and Cleaning

Do not use steam cleaning equipment.

Use protective gloves during all operations.

Carry out the required operations with the oven cold.

Disconnect the appliance from the power supply.

Do not use wire wool, abrasive scourers or abrasive/corrosive cleaning agents, as these could damage the surfaces of the appliance.

EXTERIOR SURFACES

- Clean the surfaces with a damp microfibre cloth. If they are very dirty, add a few drops of pH-neutral detergent. Finish off with a dry cloth.
- Do not use corrosive or abrasive detergents. If any of these products inadvertently comes into contact with the surfaces of the appliance, clean immediately with a damp microfibre cloth.

INTERIOR SURFACES

- After every use, leave the oven to cool and then clean it, preferably while it is still warm, to remove any deposits or stains caused by food residues. To dry any condensation that has formed as a result of cooking foods with a high water content, allow the oven to cool completely and then wipe it with a cloth or sponge.
- The door can be easily removed and refitted to facilitate cleaning of the glass.
- Clean the glass in the door with a suitable liquid detergent.

REPLACEMENT OF THE OVEN LAMP

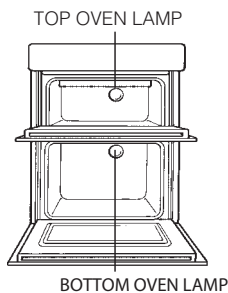

Disconnect the oven from the power supply. Unscrew the cover from the light, replace the bulb (25W - 230V - T 300 °C - E14) and screw the cover back on the light. Reconnect the oven to the power supply.

The bulb used in the product is specifically designed for domestic appliances and is not suitable for general room lighting within the home (EC Regulation 244/2009). Light bulbs are available from our After-sales Service. If using halogen bulbs, do not handle them with your bare hands as your fingerprints could cause damage. Do not use the oven until the light cover has been refitted.

ACCESSORIES

Soak the accessories in a washing-up liquid solution after use, handling them with oven gloves if they are still hot. Food residues can be removed using a washing-up brush or a sponge.

Catalytic Cleaning *

In some models, the most exposed internal vertical sides of the oven are coated with porous enamel, which is called catalytic enamel. When heated, this enamel destroys fat particles given off by the food. This „oxidation“ of the fat particles occurs when the temperature of the sides exceeds 170°C. The porous quality of the catalytic enamel increases the surface area where the exchange vital to the oxidation of the fats takes place.

If there is still grime on the catalytic surfaces after the cooking programme has ended, leave the empty oven on with the door shut, turning the temperature adjustment knob to its maximum setting. Leave the oven like this for a period of time between 60 and 90 minutes, according to how much dirt was left inside. The cleaning process for more stubborn food residues may be quickened by using hot water and a soft brush.

* Only in some models

Troubleshooting

Any problems that arise or faults that occur can often be resolved easily. Before contacting the After-sales Service, check the following table to see whether you can resolve the problem yourself. If the problem persists, contact your nearest After-sales Service Centre.



Read the safety instructions carefully before carrying out any of the following work

PROBLEM	POSSIBLE CAUSE	REMEDY
The oven is not working.	Power cut. Disconnection from the mains. Malfunction.	Check for the presence of mains electrical power and whether the oven is connected to the electricity supply. Turn off the oven and restart it to see if the problem persists.

AFTER-SALES SERVICE

BEFORE CONTACTING OUR AFTER-SALES SERVICE

1. Check whether you can resolve the problem yourself using any of the measures described in the Troubleshooting section.

2. Turn off the oven and restart it to see if the problem persists.

To receive assistance, call the number given on the warranty leaflet enclosed with the product or follow the instructions on our website. Be prepared to provide:

- a brief description of the problem;
- the exact model type of your product;
- the assistance code (the number following the word SERVICE on the identification plate attached to the product, which can be seen on the inside edge when the oven door is open);
- your full address;
- a contact telephone number.

SERVICE 0000 000 00000



Please note: If repairs are required, contact an authorised service centre that is guaranteed to use original spare parts and perform repairs correctly.

Please refer to the enclosed warranty leaflet for more information on the warranty.



400011203494